

Room thermostats with KNX communications

RDG20..KN.. & RDG26..KN..



For fan coil units, universal applications and compressors in DX-type equipment applications

- KNX bus communication (S-Mode, LTE-Mode)
- Built-in temperature, humidity and indoor air quality (CO₂: RDG204KN & RDG264KN) sensor
- Control room temperature, humidity and indoor air quality (CO₂: RDG204KN & RDG264KN) level
- Green leaf indication
- RDG20..KN triac control outputs for On/Off, PWM or 3-position
- RDG26..KN control outputs for DC 0...10 V or On/Off
- Fan outputs for 3-speed, 1-speed or DC 0...10 V
- 2 multifunctional inputs X1, X2 and 1 multifunctional input/output U1 for keycard, external sensor, etc.
- Operating modes: Comfort, Economy and Protection
- Automatic or manual fan speed control
- Automatic or manual heating/cooling changeover
- Commissioning via local HMI or with tools such as Synco™ ACS or ETS
- Commissioning via Siemens smartphone application PCT Go
- Operating voltage:
 - RDG20..KN: AC 24 V or AC 230 V (selectable)
 - RDG26..KN: AC 24 V or DC 24 V

Functions

Control application The RDG2..KN KNX room thermostats are designed for use with the following:

Fan coil units via On/Off or modulating/DC control outputs:

- 2-pipe system
- 2-pipe system with electric heater
- 2-pipe system with radiator/floor heating
- 2-pipe/2-stage system also suitable for applications with 1-stage heating/2-stage cooling, or 2-stage heating/1-stage cooling
- 4-pipe system
- 4-pipe system with electric heater
- 4-pipe system with a 6-port ball valve (RDG26..KN)
- 4-pipe system with 6-port PICV (RDG26..KN)
- 4-pipe system with PICV and 6-port ball valve as changeover (RDG26..KN)
- 4-pipe/2-stage system also suitable for applications with 1-stage heating/2-stage cooling, or 2-stage heating/1-stage cooling

Chilled/heated ceilings (or radiators) via On/Off or modulating/DC control outputs:

- Chilled/heated ceiling
- Chilled/heated ceiling with electric heater
- Chilled/heated ceiling and radiator/floor heating
- Chilled ceiling and radiator/floor heating
- Chilled and/or heated ceiling/2-stage
- Chilled/heated ceiling (4-pipe) with 6-port ball valve (RDG26..KN)
- Chilled/heated ceiling (4-pipe) with 6-port PICV (RDG26..KN)
- Chilled/heated ceiling with PICV and 6-port ball valve as changeover (RDG26..KN)

Compressor applications via On/Off control:

- Heating or cooling, compressor in DX-type equipment
- Heating or cooling, compressor in DX-type equipment with electric heater
- Heating and cooling, compressor in DX-type equipment
- Heating or cooling/2-stage, compressor in DX-type equipment

General functions

- Weekly scheduler
- M/S - manager/subordinate function between thermostats
- Room temperature control via built-in temperature sensor or external room temperature/return air temperature sensor
- Room relative humidity control via built-in humidity sensor or external room humidity sensor (humidity function can be disabled.)
- Min./max. humidity control by shifting temperature setpoint and releasing contact for dehumidifier/humidifier
- Floor heating temperature limitation
- Min. and max. supply air temperature limitation
- Selection of operating modes via operating mode button
- Button lock for all buttons independently (automatically or manually)
- Changeover between heating and cooling mode (automatic via local sensor or bus, or manually)
- Parameters protected by password (disabled by default)
- Purge function together with 2-port valve
- Valve kick/exercising function to prevent gipping
- Reminder to clean fan filters

	<ul style="list-style-type: none"> ● Indoor air quality monitoring and controlling (CO₂) via fresh air damper (RDG204KN & RDG264KN) ● Black color versions (RDG200KN/BK & RDG260KN/BK) ● Delta temperature control Limiting temperature difference between flow and return temperature for water to optimize the system and reduce energy consumption in district heating systems
Setpoints and display	<ul style="list-style-type: none"> ● Min. and max. limitation of room temperature setpoint: <ul style="list-style-type: none"> – Comfort limitation (min. and max. limitation) – Energy saving concept (min. and max. limitation separate for heating and cooling) ● Temporary Comfort mode extension ● Green leaf indication function ● Display of current room temperature or setpoint in °C, °F or both ● Absolute and relative setpoint indication ● Display of CO₂ value in ppm (parts per million) or text (GOOD; POOR; BAD: RDG204KN & RDG264KN)
Setting	<ul style="list-style-type: none"> ● Application selection via DIP switches or external commissioning software (ACS, ETS and Siemens smartphone application PCT Go) ● Parameter download with external commissioning software (ACS, ETS and Siemens smartphone application PCT Go) ● Reloading factory settings for commissioning and control parameters
Fan	<ul style="list-style-type: none"> ● 1-speed, 3-speed or DC 0...10 V fan control on RDG20..KN and RDG26..KN (automatic or manual fan) ● Advanced fan control function, e.g. fan kick, fan start delay, selectable fan operation (enable, disable, depending on heating/cooling mode, or min. and max. speed setting) ● Fan start depending on fan coil temperature (heating) to avoid cool air while heating ● Enabling fan output only in the 2nd stage (2-pipe/2-stage, 4-pipe/2-stage) ● Switching fan speed from manual to automatic in the dead zone to avoid energy waste (selectable function)
Special functions	<ul style="list-style-type: none"> ● Swap function for 2-pipe and 2-stage application by switching the 1st stage heating to 2nd stage cooling ● In 2-stage applications, limit the number of heating or cooling sequence to one ● Control of 6-port ball valve and for 6-port PICV, DC 0...10 V, DC 2...10 V and inverted signals DC 10...0 V, DC 10...2 V (RDG26..KN) ● Control of 6-port ball valve as changeover (On/Off – open/close signal) and PICV DC 0...10 V ● Control of 6-port ball valve via KNX S-Mode objects (RDG20..KN and RDG26..KN) ● Flow limitation function for PICV in heating and cooling mode (RDG26..KN) ● Set holiday period to reduce energy consumption during absences (holidays) ● For 6-port PICV (RDG26..KN) <ul style="list-style-type: none"> – During commissioning, maximal water flow selection in l/h for heating (P260) and for cooling (P261) independently via PCT Go – During operation, read water flow (l/h) via PCT Go live data function ● Selectable relay functions <ul style="list-style-type: none"> – Switch off external equipment during Protection mode – Switch on external equipment (e.g. pump) during heating/cooling demand – Output status heating/cooling sequence – Dehumidification/humidification control output

Inputs/outputs

- 2 multifunctional inputs X1, X2, and 1 multifunctional input/output U1 set as input, selectable for:
 - Window contact switches operating mode to Protection
 - Presence detector switches operating mode to Comfort
 - Sensor for automatic heating/cooling changeover
 - Switch for manual heating/cooling changeover
 - External room temperature or return air temperature sensor
 - Dewpoint sensor
 - Enable electric heater
 - Fault input
 - Monitor input for temperature sensor or switch status
 - Supply air temperature sensor
 - Coil temperature sensor
 - External temperature limit
 - Hotel presence detector
- 1 multifunctional input/output U1 set automatically as output for:
 - 4-pipe/2-stage as 2nd stage cooling output (RDG26..KN)
 - IAQ control (damper and fan) (RDG204KN & RDG264KN)

KNX communication features

- KNX bus (terminals CE+ and CE-) for communication with Synco™ devices or KNX compatible devices
- M/S - manager/subordinate function via LTE-Mode or S-Mode to synchronize equipment and save energy in open spaces
- M/S - manager/subordinate alarm management via LTE-Mode allowing for subordinate alarm display on the manager
- Display of outside temperature, humidity, CO₂ or time of day from KNX bus
- Time scheduling and central control of setpoints from KNX bus
- Control of Economy setpoints via KNX bus
- Relative humidity setpoint via KNX bus
- Control of KNX actuators and fan via S-Mode objects
- Energy supply optimization via energy demand signal via Synco™ RMB795B central control unit
- Interworking with Siemens AQR.. and QMX.. sensors for room humidity, room temperature and CO₂ measurement
- Interworking with Siemens QMX.. room operator units for room humidity, room temperature and operating commands for fan, operating mode and setpoints
- Commissioning KNX area, line and device address via mobile application PCT Go

Power supply selection for RDG20..KN

The RDG20..KN can be powered either on AC 230 V (default) or AC 24 V. To select the correct power supply, use the power switch on the rear of the device.

Note:



The outputs (triacs and relays) follow the main power supply, either AC 230 V or AC 24 V. The device will be damaged if set to AC 24 V, but powered on AC 230 V.

Applications

Remote configuration

The RDG2..KN room thermostats support the following applications, which can be configured using the DIP switches on the rear of the unit or via the commissioning tool.

Set DIP switches 1...5 to Off (remote configuration, factory setting) to select an application via commissioning tool.



Remote configuration via commissioning tool (factory setting) <ul style="list-style-type: none">• Synco™ ACS• ETS• Commissioning via Siemens smartphone application PCT Go	ON =  DIP NO.: 1...5
	OFF =  DIP NO.: 1...5

Applications for fan coil systems

Applications, DIP setting, control outputs					
<ul style="list-style-type: none"> 2-pipe fan coil unit <p>Using RDG20..KN, RDG26..KN</p>		<ul style="list-style-type: none"> 2-pipe fan coil unit with electric heater <p>Using RDG20..KN, RDG26..KN</p>		<ul style="list-style-type: none"> 2-pipe fan coil unit with radiator/floor heating <p>Using RDG20..KN, RDG26..KN</p>	
<ul style="list-style-type: none"> 2-pipe/2-stage fan coil unit <p>Using RDG20..KN, RDG26..KN</p>		<ul style="list-style-type: none"> 4-pipe fan coil unit <p>Using RDG20..KN, RDG26..KN</p>		<ul style="list-style-type: none"> 4-pipe fan coil unit with electric heater <p>Using RDG20..KN, RDG26..KN</p>	
<ul style="list-style-type: none"> 4-pipe fan coil unit with PICV and 6-port ball valve as changeover <p>Using RDG26..KN</p>		<ul style="list-style-type: none"> 4-pipe/2-stage fan coil unit ¹⁾ <p>Using RDG20..KN, RDG26..KN</p>		<ul style="list-style-type: none"> 4-pipe fan coil unit with 6-port PICV or 6-port ball valve <p>Using RDG26..KN</p>	
<ul style="list-style-type: none"> 4-pipe fan coil unit with 6-port ball valve <p>Using RDG26..KN</p>		<p>¹⁾ 4-pipe/2-stage: Output can be set to 2-stage heating/1-stage cooling or 1-stage heating/2-stage cooling</p>			
<p>YHC Heating/cooling valve actuator YH Heating valve actuator YC Cooling valve actuator YR Radiator valve actuator</p>	<p>YE Electric heater M1 1-speed or 3-speed fan, DC 0...10 V fan B1 Return air temperature sensor or external room temperature sensor (optional)</p>				

Product No.	Control output	Fan output
RDG200KN, RDG204KN	PWM, On/Off, 3-pos	3-speed, 1-speed, DC 0...10 V
RDG260KN, RDG264KN	DC 0...10 V On/Off	3-speed, 1-speed, DC 0...10 V DC 0...10 V

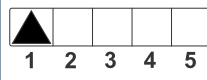
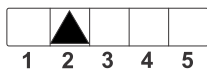
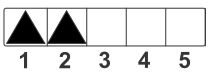
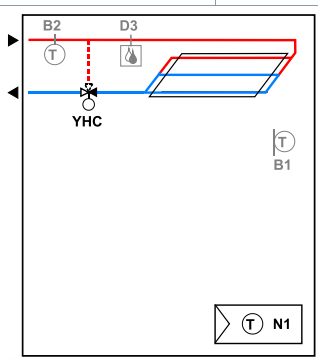
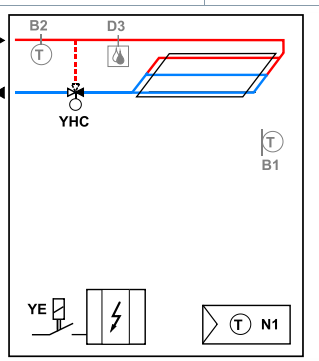
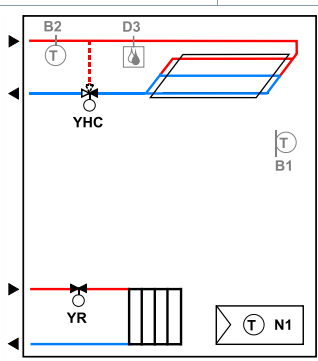
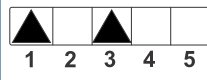
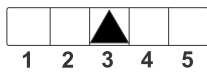
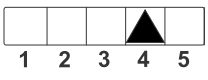
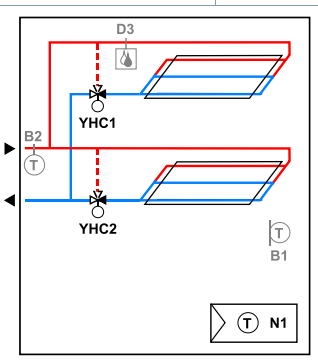
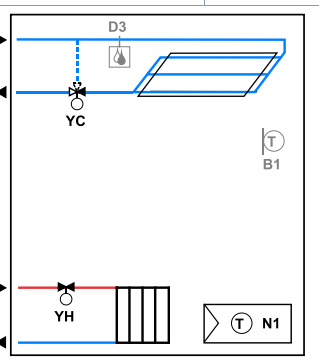
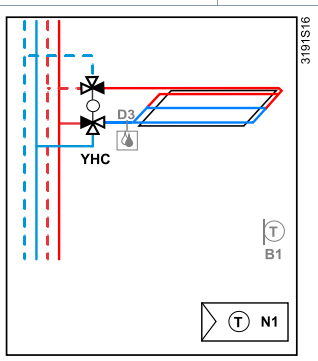
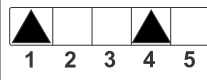
Applications for universal systems

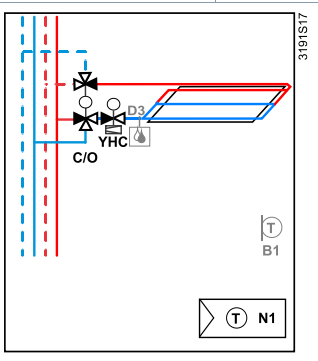
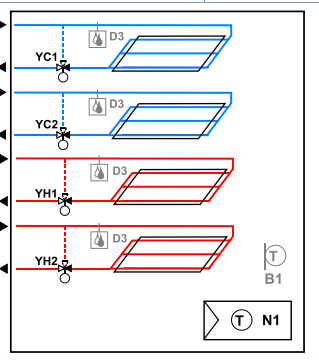
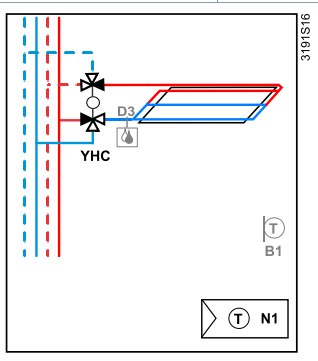
Applications, DIP setting, control outputs		
<ul style="list-style-type: none"> Chilled/heated ceiling 	<ul style="list-style-type: none"> Chilled/heated ceiling and electric heater 	<ul style="list-style-type: none"> Chilled/heated ceiling and radiator/floor heating 
 <p>Using RDG20..KN, RDG26..KN</p>	 <p>Using RDG20..KN, RDG26..KN</p>	 <p>Using RDG20..KN, RDG26..KN</p>
<ul style="list-style-type: none"> 2-stage chilled/heated ceiling 	<ul style="list-style-type: none"> Chilled ceiling and radiator 	<ul style="list-style-type: none"> Chilled and heated ceiling control with 6-port ball valve 
 <p>Using RDG20..KN, RDG26..KN</p>	 <p>Using RDG20..KN, RDG26..KN</p>	 <p>Using RDG26..KN</p>
<ul style="list-style-type: none"> Chilled and heated ceiling control with PICV and 6-port ball valve as changeover 	<ul style="list-style-type: none"> 2-stage chilled and heated ceiling 	<ul style="list-style-type: none"> Chilled and heated ceiling control with 6-port PICV 
 <p>Using RDG26..KN</p>	 <p>Using RDG20..KN, RDG26..KN</p>	 <p>Using RDG26..KN</p>
<p>YHC Heating/cooling valve actuator YH Heating valve actuator YC Cooling valve actuator</p>	<p>YE Electric heater D3 Dewpoint sensor YR Radiator valve actuator</p>	<p>B1 Return air temperature sensor or external room temperature sensor (optional) B2 Changeover sensor (optional)</p>

Product No.	Control outputs
RDG200KN, RDG204KN	On/Off, PWM, 3-position
RDG260KN, RDG264KN	On/Off, DC 0...10 V

Application for heat pump systems

Applications, DIP setting, control outputs			
<ul style="list-style-type: none"> Heated or cooled with compressors 		<ul style="list-style-type: none"> Heated or cooled with compressors with electric heater 	
<p>Using RDG20..KN, RDG26..KN</p>	<p>Using RDG20..KN, RDG26..KN</p>	<ul style="list-style-type: none"> Heated and cooled with compressors 	
<p>Using RDG20..KN, RDG26..KN</p>	<p>Using RDG20..KN, RDG26..KN</p>	<ul style="list-style-type: none"> 2-stage heated or cooled with compressors 	
<p>N1 Thermostat Output Y10/Q1: Heating or heating/cooling Output Y20/Q2: Cooling only (heating/cooling)</p>		<p>B1 Return air temperature sensor or external room temperature sensor (optional)</p>	
<p>YE Electric heaters</p>		<p>D3 Dewpoint sensor</p>	
Product No.	Control output	Fan	
RDG200KN, RDG204KN	On/Off	Disabled, 1-speed, 3-speed, DC 0...10 V	
RDG260KN, RDG264KN	On/Off	Disabled, DC 0...10 V	

Type summary

For fan coil units, universal applications and compressors in DX-type equipment applications

Product no.	Stock no.	Housing color	Operating voltage	Fan		Number of control outputs					Built-in sensor
				3-speed	DC	On/Off	PWM	3-pos	DC	On/Off (3-wire)	T: Temperature H: Humidity CO ₂
RDG200KN	S55770-T409	White	AC 24 V or AC 230 V	✓	✓ ¹⁾	4	4	2	–	2	T, H
RDG200KN/BK	S55770-T452	Black	AC 24 V or AC 230 V	✓	✓ ¹⁾	4	4	2	–	2	T, H
RDG204KN	S55770-T410	White	AC 24 V or AC 230 V	✓	✓ ¹⁾	4	4	2	1	2	T, H, CO ₂
RDG260KN	S55770-T412	White	AC 24 V or DC 24 V	✓	✓ ¹⁾	–	–	–	4	–	T, H
				–	✓ ¹⁾	2 ²⁾	–	–	–	–	
RDG260KN/BK	S55770-T453	Black	AC 24 V or DC 24 V	✓	✓ ¹⁾	–	–	–	4	–	T, H
				–	✓ ¹⁾	2 ²⁾	–	–	–	–	
RDG264KN	S55770-T413	White	AC 24 V or DC 24 V	✓	✓ ¹⁾	–	–	–	4	–	T, H, CO ₂
				–	✓ ¹⁾	2 ²⁾	–	–	–	–	

¹⁾ The terminal Y50 is used as DC 0...10 V output.

²⁾ The output is relay On/Off.

Accessories

Type	Product/stock no.	Datasheet
KNX power supply 160 mA (Siemens BT LV)	5WG1 125-1AB02	TPI_N125
KNX power supply 320 mA (Siemens BT LV)	5WG1 125-1AB12	TPI_N125
KNX power supply 640 mA (Siemens BT LV)	5WG1 125-1AB22	TPI_N125
Mounting adapter for RDG2..KN ¹⁾	ARG200: S55770-T438	–









¹⁾ ARG200 mounting adapter is used to wall-mount the RDG2..KN where a conduit box is not available. For easier wiring, removable knockouts on all sides are available. For dimensions, see Dimensions [► 32].

Ordering

When ordering, specify both product number / stock number and name: e.g. **RDG200KN / S55770-T409 room thermostat**

Order valve actuators and accessories separately.





Equipment combinations



Type of unit		Product no.	Datasheet ^{*)}
Cable temperature or changeover sensor, cable length 2.5 m NTC (3 kΩ at 25 °C)		QAH11.1	1840
Cable temperature sensor PVC 2 m, LG-Ni1000		QAP22	1831
Room temperature sensor NTC (3 kΩ at 25 °C)		QAA32	1747
Room temperature sensor LG-Ni1000		QAA24	1721
Front modules with passive temperature measurement LG-Ni1000		AQR2531ANW	1408
Strap-on temperature sensor LG-Ni1000		QAD22	1801
Condensation monitor		QXA21..	A6V10741072
Flush-mount KNX room sensor (base and front module)		AQR2570N.. AQR2532NNW AQR2533NNW AQR2535NNW	1411
Wall-mounted KNX sensors		QMX3.P30 QMX3.P70	1602

On/Off and PWM actuators ¹⁾





Type of unit	Product no.	Datasheet ^{*)}
Thermal actuator (for radiator valves) AC 230 V, NC	Under development	
Thermal actuator (for radiator valves) AC 24 V, NC		
Thermal actuator AC 230 V (for small valves 2.5 mm), NO		
Thermal actuator AC 24 V (for small valves 2.5 mm), NO		

3-position actuators AC 230 V



Type of unit		Product no.	Datasheet ^{*)}
Electric actuator, 3-position (for radiator valves) AC 230 V		SSA331..	A6V11858276
Electric actuator, 3-position (for 2- and 3-port valves/V..P45) AC 230 V		SSC31	4895
Electric actuator, 3-position (for small valves 2.5 mm) AC 230 V		SSP31..	4864
Electric actuator, 3-position (for small valves 5.5 mm) AC 230 V		SSB31..	4891
Electric actuator, 3-position (for small valve 5 mm) AC 230 V		SSD31..	4861

Type of unit		Product no.	Datasheet ^{*)}
Electric actuator, 3-position (for valves 5.5 mm) AC 230 V		SAS31..	4581
Rotary actuators for ball valves, 3-position		GDB331.9E	4657
Rotary actuators for ball valves, 2 or 3-position		GDB141.9E GDB341.9E	A6V10636150





3-position actuators
AC 24 V



Type of unit		Product no.	Datasheet ^{*)}
Electric actuator, 3-position (for radiator valves) AC 24 V		SSA131..	A6V11858276
Electric actuator, 3-position (for 2- and 3-port valves/V..P45) AC 24 V		SSC81	4895
Electric actuator, 3-position (for small valves 2.5 mm) AC 24 V		SSP81..	4864
Electric actuator, 3-position (for small valves 5.5 mm) AC 24 V		SSB81..	4891
Electric actuator, 3-position (for small valve 5 mm) AC 24 V		SSD81..	4861

On/Off actuators

Type of unit		Product no.	Datasheet ^{*)}
Electromotive On/Off actuator		SFA21.. SFA71..	4863
Electromotive On/Off valve and actuator (only available in AP, UAE, SA and IN)		MVI../MXI..	A6V11251892
Zone valve actuator (only available in AP, UAE, SA and IN)		SUA	A6V10446174

DC 0...10 V actuators

Type of unit		Product no.	Datasheet ^{*)}
Electric actuator, DC 0...10 V (for radiator valves)		SSA161..	A6V11858278
Electric actuator, DC 0...10 V (for 2- and 3-port valves/V..P45)		SSC161..	A6V12681511
Electric actuator, DC 0...10 V (for small valves 2.5 mm)		SSF161..	A6V12681511
Electric actuator, DC 0...10 V (for small valves 5.5 mm)		SSB161..	A6V12681511





Type of unit		Product no.	Datasheet *)
Electromotive actuator, DC 0...10 V (for valves 5.5 mm)		SAS61..	4581
Electrothermal actuator, AC 24 V, NC, DC 0...10 V, 1 m		Under development	
Electrothermal actuator, AC 24 V, NO, DC 0...10 V, 1 m			
Rotary actuators for ball valves AC 24 , DC 0...10 V		GDB161.9E	4657

DC 0...10 V actuators 6-port / PICV (RDG26..KN)

Type of unit		Product no.	Datasheet *)
Rotary actuators for 6-port ball valves control: <ul style="list-style-type: none"> • 6-port ball valve VWG41.. • 6-port PICV VWPG51.. For details, see Recommended RDG actuators and 6-port valves combinations [► 12]		GDB161.9../6W	A6V12986395

Note: Set the control signal accordingly if RDG26.. is required to control GDB161.9E, see Control output configuration for 6-port valve in [Basic documentation](#).

DC 0...10 V damper actuators

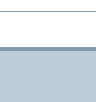

Type of unit		Product no.	Datasheet *)
Air damper actuators DC 0...10 V, AC/DC 24 V		GQD166.1A GQD161.1A	4604
Air damper actuators DC 0...10 V, AC 24 V		GDB16..1 GLB16..1	4634
Air damper actuators DC 0...10 V, AC/DC 24 V		GMA16..1	4614
Air damper actuators DC 0...10 V, AC 24 V		GEB16..1	4621
Air damper actuators DC 0...10 V, AC/DC 24 V		GCA16..1	4613
Air damper actuators DC 0...10 V, AC 24 V		GBB16..1 GIB16..1	4626

On/Off damper actuators AC 230 V

Type of unit		Product no.	Datasheet *)
Air damper actuators 2-position, AC 230 V		GQD32..1	4604
		GMA32..1	4614

Type of unit		Product no.	Datasheet ^{*)}
		GCA32..1	4613

On/Off damper
actuators
AC 24 V

Type of unit		Product no.	Datasheet ^{*)}
Air damper actuators 2-position, AC/DC 24 V		GQD12..1	4604
		GMA12..1	4614
		GCA12..1	4613

KNX actuators

Type of unit		Product no.	Datasheet ^{*)}
Rotary actuators for ball valves KNX S-Mode		GDB111.9E/KN	A6V10725318

^{*)} The documents can be downloaded from <https://hit.sbt.siemens.com>

¹⁾ With PWM control, exact parallel run of 2 or more thermal actuators is not possible. If several fan coil units are controlled by the same room thermostat, motorized actuators with On/Off or 3-position control are preferred.

Note:

For more information about parallel operation and the max. number of actuators that can be used, refer to the data sheets of the selected actuator type and the following list:

Max. number of actuators in parallel on RDG20..KN (AC 230 V):

- 6 SS..31.. actuators (3-position)
- 10 SFA.., SUA.., MVI.., MXI.. On/Off actuators
- Parallel operation of SAS31 not available

Max. number of actuators in parallel on RDG20..KN (AC 24 V):

- 6 SS..31.. actuators (3-position)
- 2 SFA71.. On/Off actuators
- Parallel operation of SAS81 not available

Max. number of actuators in parallel on RDG26..KN (AC 24 V):

- 10 SS..61.. actuators (DC)
- 10 SFA.., SUA.., MVI.., MXI.. On/Off actuators
- 10 SAS61.. actuators (DC)
- 10 GDB161.9E

Recommended RDG actuators and 6-port valves combinations

Use the following RDG260..KN versions (see below) to ensure the optimal temperature control performance of GDB161.9../6W actuators (with 6-port ball valves VWG41.. or 6-port PICV VWPG51..):

- RDG26..KN.. with product index D or higher

Check the device version compatibility in Control output configuration for 6-port valve in [Basic documentation](#) for applications with older RDG product indices, GDB161.9E or competitor actuators.

Mechanical design

The room thermostat consists of two parts:

- Plastic housing with electronics, operating elements, and room temperature sensor
- Mounting plate with screw terminals

The housing engages in the mounting plate and is secured with 2 screws.

Operation and settings

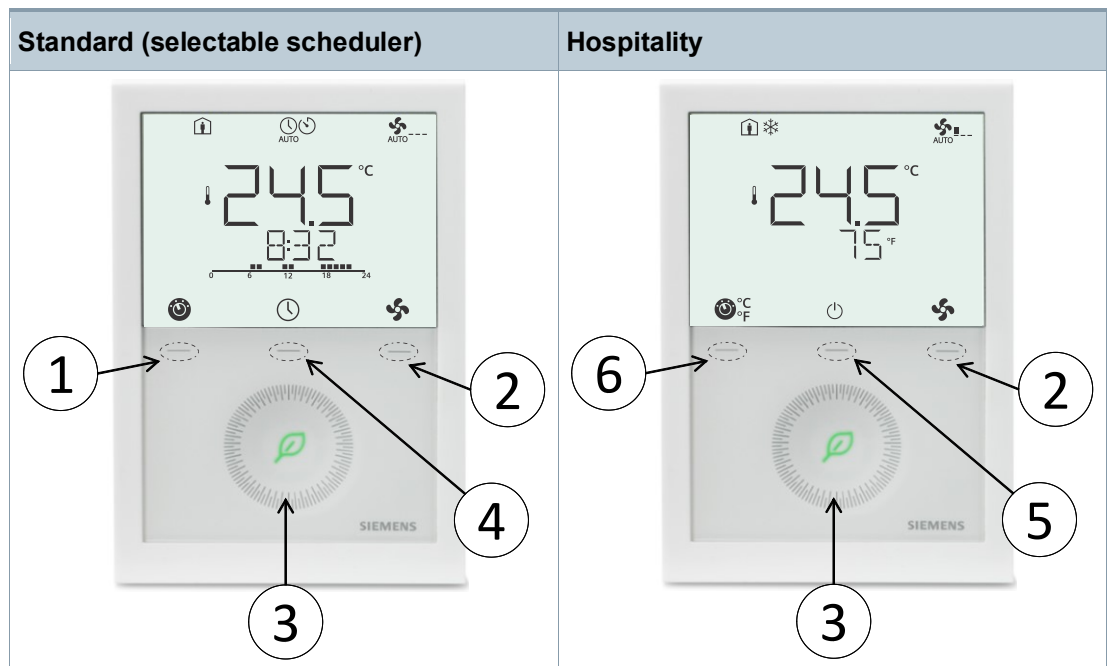

Number	Description
①	Operating mode button/Esc
②	Fan mode button/OK
③	Capacitive rotary knob to adjust setpoints and parameters
④	Local schedule setting button, the schedule is enabled via P005
⑤	Protection hospitality mode button
⑥	°C °F Unit switching between °C and °F

Display

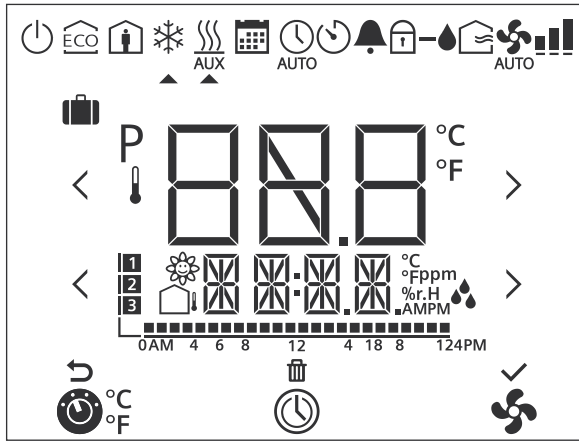

#	Symbol	Description	#	Symbol	Description
1		Operating mode selection/Unit switching	2		Scheduler
3		Fan speed selection	4		Escape
5		Delete schedule	6		Confirm parameters
7		Time bar for schedule	8		Number of schedules or subordinate alarms
9		Indoor air quality	10		Outside temperature
11		Additional user information, such as outside temperature, time of day from KNX bus, relative humidity, or IAQ	12	AMPM	Morning: 12-hour format Afternoon: 12-hour format
13		Relative humidity	14		Degrees Celsius or Fahrenheit
15		CO ₂ values	16		Parameter
17		Value with thermometer: Digits for room temperature display	18		Digits for setpoint display
19		Holiday mode	20		Protection mode
21		Economy mode	22		Comfort mode
23		Cooling mode	24		Heating mode, electric heater active
25		Heating mode	26		Manual changeover, heating/cooling mode
27		Scheduler mode	28		Auto mode
29		Temporary timer	30		Fault
31		Button lock	32		Condensation in room (dewpoint sensor active) or humidity control active
33		Fresh air indication	35		Fan speed Fan speed I
34		Automatic fan			Fan speed II
					Fan speed III

Green leaf indication

Green leaf indication (green or red leaf) informs users if equipment operates within the energy-efficient setting range (leaf is green).

When the setting exceeds the preset energy efficiency range, the leaf color changes to red. End users can press the red leaf to return to the energy efficiency.



The functions are defined as follows:

- Green leaf: Settings are within the preset energy-efficiency range:
 - The setpoint range is defined by the Comfort basic setpoint (P011) plus/minus the energy indicator range (P111). It applies only to the Comfort setpoint concept (P010 = 1)
 - Fan speed: The manual fan is below or equal to the auto fan speed value
 - Operating mode: The manual mode is lower or equal to the scheduler mode

- Red leaf: The settings exceed the preset energy-efficiency range

P110 configures the green leaf function:

- 0 = Disabled (OFF)
- 1 = Green and red dimmed down
- 2 = Green dimmed down / red fixed
- 3 = Green and red fixed

	
<p>Energy-efficient setting</p>	<p>Exceed the preset energy-efficient range Touch to reset user setting</p>

Title	Document ID
Mounting instructions	RDG200KN, RDG204KN: A6V11546008 RDG260KN, RDG264KN: A6V11844861
Operating instructions	A6V11545973
Basic documentation	A6V11545892
CE declarations	A5W00120120A
RCM	A5W00120121A
Environmental product declaration	RDG200KN: A5W00085404A RDG200KN/BK: A5W00242785A RDG204KN: A5W00242787A RDG260KN: A5W00116569A RDG260KN/BK: A5W00242797A RDG264KN: A5W00242790A

Related documents such as environmental declarations, CE declarations, etc., can also be downloaded at the following Internet address:

<http://siemens.com/bt/download>

Notes

Security

	<p>⚠ CAUTION</p>
	<p>National safety regulations</p> <p>Failure to comply with national safety regulations may result in personal injury and property damage.</p> <ul style="list-style-type: none"> • Observe national provisions and comply with the appropriate safety regulations.

Mounting and installation

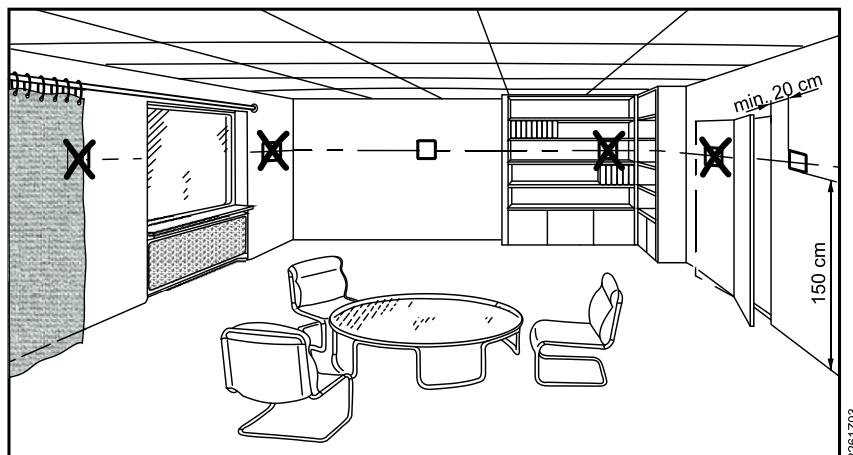

- Mounting
- The devices are suitable for wall mounting.
 - ⚠ **Warning! Do not mount the device on a metallic surface: Use mounting adapter ARG200 where this is not possible.**
 - Recommended height: 1.5 m above the floor.
 - Do not mount the devices in recesses, shelves, behind curtains or doors, or above or near heat sources.
 - Avoid direct solar radiation and drafts.
 - Avoid unheated (uncooled) building area such as outside walls.
 - Seal the conduit box or the installation tube if any, as air currents can affect sensor readings.
 - Adhere to allowed ambient conditions.
 - An external room temperature sensor is recommended if above situations cannot be avoided in the installation area.
- Wiring
- Comply with local regulations to wire, protect and earth the thermostat.
 - ⚠ **Warning! No internal line protection for supply lines to external consumers (Q1, Q2, Q3, Yx or Yxx)! Risk of fire and injury due to short-circuits!**
 - Adapt the line diameters as per local regulations to the rated value of the installed over current protection device.
 - The AC 230 V mains supply line must have an external circuit breaker with a rated current of no more than 10 A.
 - ⚠ Properly size the cables to the thermostat, fan and valve actuators for AC 230 V mains voltage.
 - ⚠ Use valve actuators rated for AC 230 V / AC 24 V / DC 24 V depending on mains voltage.
 - ⚠ Inputs X1-M, X2-M or U1-M: Multiple switches (e.g. summer/winter switch) may be connected in parallel. Consider overall maximum contact sensing current for switch rating.
 - ⚠ When mains voltage is AC 230 V, SELV inputs X1-M, X2-M and U1-M use cables with min. 230 V insulation.
 - Selectable relay function: Follow instructions in basic documentation A6V11545892 (Relay functions) to connect external equipment to the relay outputs.
 - ⚠ Disconnect thermostat from power supply before removing from the mounting plate.
 - ⚠ If a KNX bus power supply is connected to the line with communicating thermostats and Synco™ controller, the internal KNX power supply of the Synco™ controllers must be switched off.

Commissioning

- Applications and settings
- The room thermostats are delivered with a fixed set of applications and related parameters. Select and activate the relevant application and settings during commissioning using one of the following tools:
- Local DIP switches and HMI
 - Synco™ ACS
 - ETS5 or higher versions
 - Siemens smartphone application PCT Go
- DIP switches
- Set the DIP switches before snapping the thermostat to the mounting plate when selecting an application via DIP switches.
- Set all DIP switches to Off (remote configuration) when selecting an application via commissioning tool.
- After power is On, the thermostat resets and all LCD segments light up, indicating that reset is correct. After the reset of 3 seconds, the thermostat is ready for commissioning by qualified HVAC staff.

If all DIP switches are Off, **NO APPL** displays, indicating that application commissioning via a tool is required.

Commissioning via Siemens smartphone application PCT Go

The setting via the Siemens smartphone application Product Commissioning Tool (PCT Go) is used to set the application and parameters settings of the thermostat.

DIP switches can be either all set to Off or preset with an application. (DIP switch setting has higher priority.)

This tool allows for wireless setting of the thermostat with smartphone and read/write parameters.

The commissioning tool works directly after users scan either the antenna area of the thermostat or the NFC area on the individual package box.

In addition, users can:

- Scan the antenna area without powering on the thermostat.
- Scan the NFC area without unpacking the thermostat from the individual box.

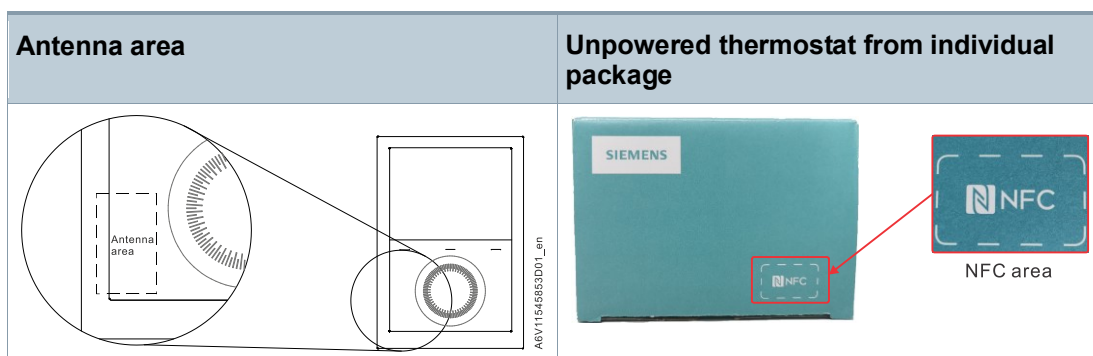

Notes

- Each time the application is changed, the thermostat reloads the factory settings for all control parameters excepting KNX device and zone addresses.
- The commissioning via Siemens smartphone application PCT Go can be disabled via parameters to avoid unexpected changes of the thermostat.

Connect tools

Connect the Synco™ ACS or ETS tools to the KNX bus cable at any point for commissioning.

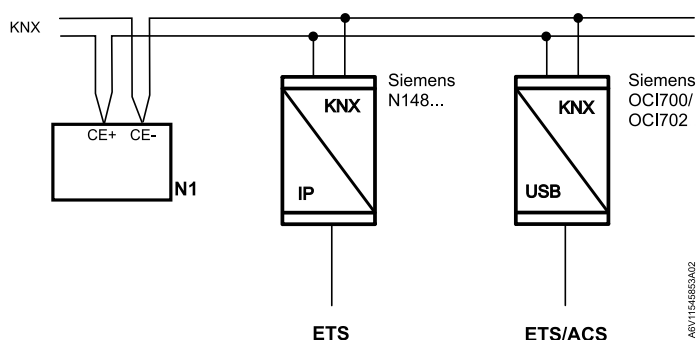

ACS and ETS require an interface:

- KNX interface (e.g. Siemens N148...)
- OCI702 USB-KNX interface

Control sequence Set the control sequence via parameter P001 depending on the application. Factory setting:

Application	Factory setting P001
2-pipe and chilled/heated ceiling, and 2-stage	1 = cooling only
4-pipe, chilled ceiling and el. heater, 6-port ball valve applications, and 2-stage	4 = heating and cooling

Calibrate sensor Recalibrate the temperature sensor, if the room temperature displayed on the thermostat does not match the room temperature measured (after min. 1 hour of operation). To do this, change parameter P006.

Setpoint and range limitation We recommend to review the setpoints and setpoint ranges (P011, P013...P016, P019, P020) and change them as needed to achieve maximum comfort and save energy.

Programming mode The programming mode helps identify the thermostat in the KNX network during commissioning.
Touch both the left and right buttons simultaneously for 6 seconds to activate programming mode, indicated on the display by **PROG**.
Programming mode remains active until thermostat identification is complete.

Assign KNX address Assign complete KNX address (area, line and device) via:

- HMI or Siemens smartphone application PCT Go by setting parameters P898 (area address), P899 (line address) and P900 (device address)
- ACS or ETS (P900: device address)

Set the device address to 255 to deactivate the communication (no exchange of process data).

Assign KNX group address Use ETS to assign the KNX group addresses of the thermostat's communication objects.

KNX serial number Each device has a unique KNX serial number on the rear.
An additional sticker with the same KNX serial number is enclosed in the package. This sticker is intended for documentation purposes of installers.

Disposal



This symbol or any other national label indicate that the product, its packaging, and, where applicable, any batteries may not be disposed of as domestic waste. Delete all personal data and dispose of the item(s) at separate collection and recycling facilities in accordance with local and national legislation.
For additional details, refer to [Siemens information on disposal](#).

Open Source Software (OSS)

All open source software components used within the product (including their copyright holders and the license conditions) can be found from the website <http://www.siemens.com/download?A6V12046962>.



Warranty

Technical data on specific applications are valid only together with Siemens products listed under "Equipment combinations". Siemens rejects any and all warranties in the event that third-party products are used.

Power supply (RDG20..KN)	
Operating voltage (L-N)	AC 24 V \pm 20 % or AC 230 V +10/-15 % (selectable via slider)
Frequency	50/60 Hz
Power consumption	4 VA @ AC 24 V 7 VA @ AC 230 V
 <ul style="list-style-type: none"> • No internal fuse! External preliminary protection with max. C 10 A circuit breaker required in all cases. • Before switching on power, select the right power supply needed using the power switch on the rear of the device. 	

Outputs (RDG20..KN)	
Fan control Q1, Q2, Q3 – N	AC 24 V or AC 230 V (linked to power supply)
Qx rating min., max. resistive (inductive)	5 mA...5 (4) A
 <p>No internal fuse! External preliminary protection with max. C 10 A circuit breaker required for all cases.</p>	
<p>!</p> <p>Do not connect 3-speed fans in parallel! Connect one fan directly, one relay for each speed for additional fans.</p>	
Use for actuator control (Q1, Q2)	
<ul style="list-style-type: none"> • Q1 - rating min., max. resistive/inductive • Q2 - rating min., max. resistive/inductive 	5 mA...1 A 5 mA...1 A
Use for external equipment (Q1, Q2, Q3)	
<ul style="list-style-type: none"> • Rating min., max. resistive/inductive Qx • Max total load current Q1+Q2+Q3 	5 mA...1 A 2 A
DC 0...10 V fan control; Y50-M	SELV DC 0...10 V, max. \pm 5 mA
Damper control (RDG204KN): DC (U1) On/Off (Q3/Y4)	SELV DC 0...10 V, \pm 1 mA See Qx and Y4
Control outputs Y1, Y2, Y3, Y4-N Yx power limitation	Solid state (triacs) AC 24 V or AC 230 V (linked to power supply) 8 mA...1 A 3 A fast microfuse, cannot be exchanged

Power supply (RDG26..KN)	
Operating voltage (G-G0) DC 24 V: Make sure to connect G to + and G0 to -	AC 24 V \pm 20 % DC 24 V \pm 2 V
Frequency	50/60 Hz
Power consumption	4 VA @ AC 24 V
 No internal fuse! External preliminary protection with max. C 10 A circuit breaker required for all cases.	

Outputs (RDG26..KN)	
Fan control Q1/Q2/Q3/L-N	AC 24...230 V / DC 24 V
Use for 3-speed fan control Rating min, max resistive (inductive)	AC 24...230 V: 5 mA...5 (4) A DC 24 V: 3 A
 No internal fuse! External preliminary protection with max. C 10 A circuit breaker required for all cases.	
 Do NOT connect 3-speed fans in parallel! Connect one fan directly, for additional fans, one relay for each speed.	
Use for actuator control (Q1, Q2)	
<ul style="list-style-type: none"> Q1 - rating min., max. resistive/inductive Q2 - rating min., max. resistive/inductive Max total load current Q1+Q2 	5 mA...1 A 5 mA...5 (4) A 5 A
Use for external equipment (Q1, Q2, Q3)	
<ul style="list-style-type: none"> Rating min., max. resistive/inductive Qx Max total load current Q1+Q2+Q3 	5 mA...1 A 2 A
 No internal fuse! External preliminary protection with max. C 10 A circuit breaker required for all cases.	
DC 0...10 V fan control (Y50-M)	SELV DC 0...10 V, max. \pm 5 mA
Actuator control (Y10-G0/Y20-G0/Y30-G0 (G))	SELV DC 0...10 V, max. \pm 1 mA
Damper control (RDG264KN): DC (U1) On/Off (Q3)	SELV DC 0...10 V, \pm 1 mA See Qx

Multifunctional inputs	
X1-M/X2-M/U1-M	
Temperature sensor input	
Type	NTC 3k
Temperature range	-20...70 °C
Temperature sensor input	
Type	LG-Ni1000
Temperature range	-40...70 °C
Digital input	
Operating action	Selectable (NO/NC)
Contact sensing	DC 0...5 V, max. 5 mA
Insulation against mains	SELV

KNX bus	
Interface type	KNX, TP Uart 2 (electrically isolated)
Bus current	5 mA
Bus topology: See KNX manual ("Reference documentation")	

Operational data		
Switching differential, adjustable		
Heating mode	(P051)	1 K (0.5...6 K)
Cooling mode	(P053)	1 K (0.5...6 K)
P-band Xp		
Heating mode	(P050)	2 K (0.5...6 K)
Cooling mode	(P052)	1 K (0.5...6 K)
Setpoint setting and setpoint range		
Comfort mode	(P011)	21 °C (5...40 °C)
Economy mode	(P019-P020)	15 °C/30 °C (OFF, 5...40 °C)
Protection mode	(P100-P101)	8 °C/OFF (OFF, 5...40 °C)
Multifunctional inputs X1/X2/U1		Selectable (0...14)
Input X1 default value	(P150)	1 (external temperature sensor, room or return air)
Input X2 default value	(P153)	0 (no function)
Input U1 default value	(P155)	RDG2..0KN: 3 (window contact) RDG2..4KN: 0 (no function)

Operational data	
Built-in room temperature sensor	
Measuring range	0...49 °C
Accuracy at 25 °C	< ±0.5 K
Temperature calibration range	±3 K
Built-in humidity sensor	
Measuring range	10...90 %
Accuracy (after calibration via P007)	< 5 %
Humidity calibration range	±10 %
Built-in CO ₂ sensor	
Measuring range	0...5000 ppm
Measuring accuracy at 25 °C and 1013 hPa	±(50 ppm +4 % of measured value)
Temperature stability in the range of 0..50 °C	3 ppm / °C
Long-time drift	80 ppm over 5 years (typically)
Time constant t ₆₃	< 5 min
Calibration	ASC
Settings and display resolution	
Setpoint	0.5 °C
Present temperature value displayed	0.5 °C

Environmental conditions	
Storage	IEC 60721-3-1
Climatic conditions	Class 1K3
Temperature	-25...65 °C
Humidity	< 95 % r.h.
Transport	IEC 60721-3-2
Climatic conditions	Class 2K3
Temperature	-25...65 °C
Humidity	< 95 % r.h.
Mechanical conditions	Class 2M2
Operation	IEC 60721-3-3

Environmental conditions	
Climatic conditions	Class 3K5
Temperature	0...50 °C
Humidity	< 95 % r.h.

Standards and directives	
EU conformity (CE)	A5W00120120A*
Electronic control type	2.B (micro-disconnection on operation)
RCM conformity	A5W00120121A*
Protection class	II as per EN 60730
Pollution class	Normal
Degree of protection of housing	IP30 as per EN 60529
Eco design and labeling directives	Based on EU directive 813/2013 (Eco design directive) and 811/2013 (Labelling directive) concerning space heaters, combination heaters, the following classes apply:
RDG20..KN <ul style="list-style-type: none"> Application with On/Off operation of a heater PWM (TPI) room thermostat, for use with On/Off output heaters 	Class I value 1 % Class IV value 2 %
RDG26..KN <ul style="list-style-type: none"> Application with On/Off operation of a heater PWM (TPI) room thermostat, for use with On/Off output heaters 	Class I value 1 % Class IV value 2 %

Meets the requirements for eu.bac certification
See product list at: <http://www.eubacert.eu/licences-by-criteria.asp>



Application	Device	Actuator outputs	CA value (K)	License No.
Fan coil units (2 pipes)	RDG20..KN	Thermal actuator	Heating 0.4 Cooling 0.3	220019
	RDG26..KN	Motorized DC	Heating 0.1 Cooling 0.1	220020

Fan coil units (2 pipes,2 wires)	RDG20..KN	Thermal actuator	Heating 0.1 Cooling 0.3	220019
	RDG26..KN	Motorized DC	Heating 0.1 Cooling 0.1	220020
Variable speed fan	RDG20..KN	Thermal actuator	Heating 0.4 Cooling 0.3	220019
	RDG26..KN	Motorized DC	Heating 0.1 Cooling 0.1	220020
Ceiling systems	RDG26..KN	Motorized DC	Heating 0.2 Cooling 0.2	220020
		6-port control ball valves VWG41.10...	Heating 0.2 Cooling 0.4	220020
		6-port control ball valves VWG41.20...	Heating 0.2 Cooling 0.4	220020
Environmental compatibility	The product environmental declaration (RDG200KN: A5W00085404A*, RDG260KN: A5W00116569A*, RDG200KN/BK: A5W00242785A*, RDG260KN/BK: A5W00242797A*, RDG204KN: A5W00242787A*, RDG264KN: A5W00242790A*) contains data on environmentally compatible product design and assessments (RoHS compliance, materials composition, packaging, environmental benefit, disposal).			

General	
Connection terminals	Solid wires or stranded wires with wire-end sleeves 1 x 0.4...2.5 mm ² or 2 x 0.4...1.5 mm ²
Minimal wiring cross section on L, N, Q1, Q2, Q3, Y1, Y2, Y3, Y4	Min. 1.5 mm ²
Maximal wiring cross section on L, N, Q1, Q2, Q3, Y1, Y2, Y3, Y4	Max. 2.5 mm ²
Housing front color	RAL 9016 white RAL 9011 black (RDG2..KN/BK)
Weight without/with packaging RDG200KN / RDG200KN/BK RDG204KN RDG260KN / RDG260KN/BK RDG264KN	266 g/336 g 270.3 g/345.9 g 242 g/311 g 269.5 g/324.6 g
Reference documentation	Handbook for Home and Building Control - Basic Principles (EN: https://my.knx.org/shop/product?language=en&product_type_category=books&product_type=handbook DE: https://my.knx.org/shop/product?language=de&product_type_category=books&product_type=handbook)
Synco™	CE1P3127 Communication via KNX bus for Synco 700, 900 and RXB/RXL Basic documentation
Desigo	CM1Y9775 Desigo RXB integration – S- Mode CM1Y9776 Desigo RXB/RXL integration – individual addressing CM1Y9777 Third-party integration CM1Y9778 Synco integration CM1Y9779 Working with ETS

*) The documents can be downloaded from <https://hit.sbt.siemens.com>.

Diagrams

Connection terminals

RDG20..KN

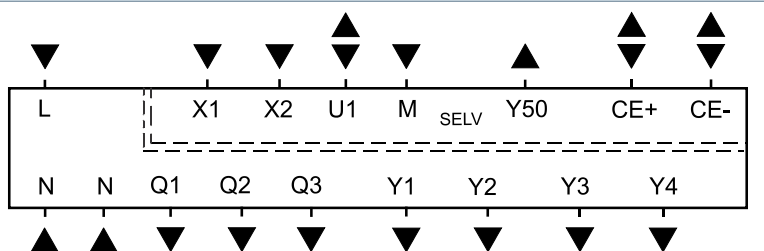

L, N	Operating voltage AC 230 V / AC 24 V
X1, X2	Multifunctional input for temperature sensor (NTC 3k or LG-Ni1000) or potential-free switch (function can be selected via parameter)
U1	Selectable input/output function: <ul style="list-style-type: none"> • Multifunctional input for temperature sensor (NTC 3k or LG-Ni1000) or potential-free switch (function can be selected via parameter) • Multifunctional output DC 0...10 V for fresh air damper
M	Measuring neutral for sensors and switches
CE+, CE-	KNX Bus + and – terminals
Q1	Control output for fan speed I AC 230 V / AC 24 V
Q2	Control output for fan speed II AC 230 V / AC 24 V
Q3	Control output for fan speed III AC 230 V / AC 24 V
Q1...Q3	Also for special functions AC 230 V / AC 24 V
Y1...Y4	Control outputs "Valve" AC 230 V or AC 24 V (Normally open triac, for normally closed valves), output for electric heater via external relay
Y50	Control output "Fan" DC 0...10 V

RDG26..KN

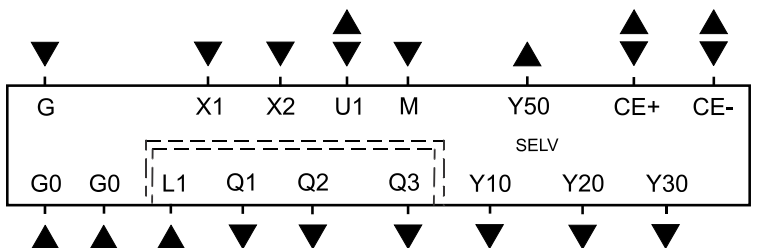

G, G0	Operating voltage AC 24 V / DC 24 V
L1	Feed for relays AC 24...230 V
X1, X2	Multifunctional input for temperature sensor (NTC 3k or LG-Ni1000) or potential-free switch (function can be selected via parameter)
U1	Selectable input/output function: <ul style="list-style-type: none"> • Multifunctional input for temperature sensor (NTC 3k or LG-Ni1000) or potential-free switch (function can be selected via parameter) • Multifunctional output DC 0...10 V for fresh air damper or for 2nd stage cooling in 4-pipe/2-stage application
M	Measuring neutral for sensors and switches
CE+, CE-	KNX bus + and – terminals
Q1 (L1)	Control output for fan speed I AC 230 V / AC 24 V
Q2 (L1)	Control output for fan speed II AC 230 V / AC 24 V
Q3 (L1)	Control output for fan speed III AC 230 V / AC 24 V
Q1...Q3 (L1)	For special functions AC 24...230 V
Y10, Y20, Y30	Control outputs "Valve" DC 0...10 V
Y50	Control output "Fan" DC 0...10 V

Connection diagrams

The connection workflow is as follows:

- Select fan control type: DC, 1-speed or 3-speed fan
- Select application type, e.g. 4-pipe
- Columns V1, V2, V3, V4 show the type of the outputs (e.g. for 4-pipe: YH for heating and YC for cooling) as well the available control signals
- Select the requested control output signals (e.g. 2-pos for heating, 2-pos for cooling)
- Equipments V1, V2 etc. stands for the connected equipment on each terminal, e.g. 4-pipe with outputs of 2-pos and 2-pos, V1 (valve actuator) connects to Y1 and V2 (valve actuator) to Y2

Notes

- "2-pos" can be used for control signal On/Off and PWM
- For universal application, fan function needs to be switched off via P350

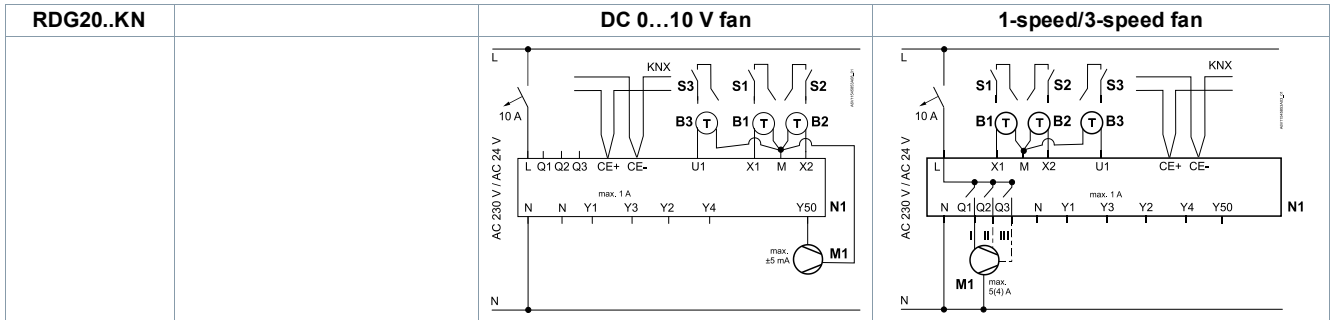

Application		Equipment		Terminals				Terminals						
	V1			Y1	Y3			Y50	Q1, Q2, Q3	Y1	Y3			
2-pipe	YHC													
Control outputs:	2-pos			V1				✓	✓	V1				
	3-pos			▲ V1 ▼						▲ V1 ▼				
Application		Equipment		Terminals				Terminals						
	V1	V2		Y1	Y3	Y2	Y4	Y50	Q1, Q2, Q3	Y1	Y3	Y2	Y4	
2-pipe + RAD	YHC	YR												
4-pipe	YH	YC						✓	✓					
2-pipe/2-stage	YHC1	YHC2												
Control outputs:	2-pos	2-pos		V1		V2				V1		V2		
	2-pos	3-pos		V1		▲ V2 ▼		✓	✓	V1		▲ V2 ▼		
	3-pos	2-pos		▲ V1 ▼		V2				▲ V1 ▼		V2		
	3-pos	3-pos		▲ V1 ▼		▲ V2 ▼				▲ V1 ▼		▲ V2 ▼		
Application		Equipment		Terminals				Terminals						
	V1	V2		Y1	Y3	Y2	Y4	Y50	Q1, Q2, Q3	Y1	Y3	Y2	Y4	
2-pipe with electric heater	YHC	YE												
Control outputs:	2-pos	2-pos		V1		V2				V1		V2		
	2-pos	3-pos		V1		▲ V2 ▼		✓	✓	V1		▲ V2 ▼		
	3-pos	2-pos		▲ V1 ▼		V2				▲ V1 ▼		V2		
	3-pos	3-pos		▲ V1 ▼		▲ V2 ▼				▲ V1 ▼		▲ V2 ▼		
Application		Equipment		Terminals				Terminals						
	V1	V2	V3	Y1	Y2	Y4	Y3	Y50	Q1, Q2, Q3	Y1	Y2	Y4	Y3	
4-pipe with electric heater	YH	YC	YE											
Control outputs:	2-pos	2-pos	2-pos	V1	V2		V3			V1	V2		V3	
	2-pos	3-pos	2-pos	V1	▲ V2 ▼		V3	✓	✓	V1	▲ V2 ▼		V3	
Application		Equipment		Terminals				Terminals						
	V1	V2	V3	V4	Y1	Y2	Y3	Y4	Y50	Q1, Q2, Q3	Y1	Y2	Y3	Y4
4-pipe/2-stage	YH1	YC1	YH2	YC2										
Control outputs:	2-pos	2-pos	2-pos	2-pos	V1	V2	V3	V4	✓	✓	V1	V2	V3	V4

- N1 Room thermostat RDG20..KN
- S1, S2, S3 Switch (keycard, window contact, presence detector etc.)
- B1, B2, B3 Temperature sensor (return air temperature, external room temperature, changeover sensor, etc.)
- V1, V2, V3, V4 Valve actuators: On/Off or PWM, 3-position, heating, cooling, radiator, heating/cooling, 1st or 2nd stage
- YH Heating valve actuator
- YE Electric heater
- YC Cooling valve actuator
- K Relay
- YHC Heating/cooling valve actuator
- CE+ KNX data +
- YR Radiator valve actuator
- CE- KNX data -
- YHC1/YH1/ YH2/YHC2/ YC1/YC2 1st/2nd stage
- M1 1-speed or 3-speed fan, DC 0...10 V fan

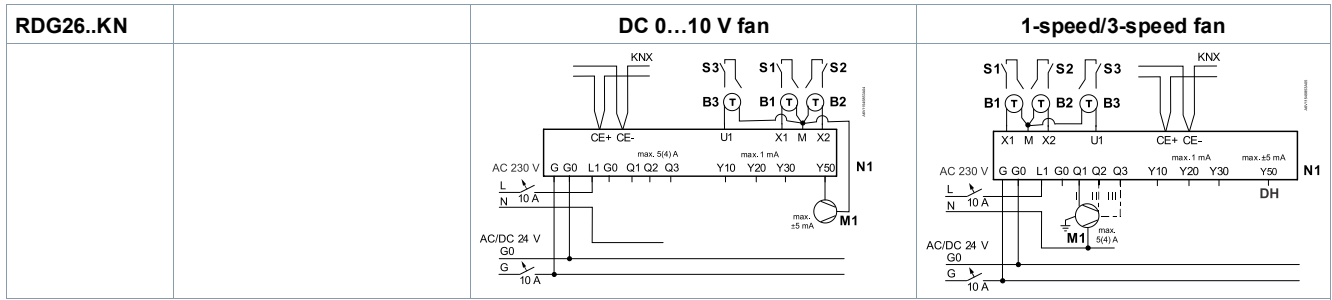

Application	Equipment	Terminals					Terminals						
	V1					Q1	Y10	Y50	Q1, Q2, Q3	Y10			
2-pipe	YHC												
Control outputs:	DC					V1		✓	✓	V1			
	On/Off					V1							

Application	Equipment		Terminals					Terminals					
	V1	V2											
2-pipe + RAD	YHC	YR											
4-pipe	YH	YC											
2-pipe/2-stage	YHC1	YHC2											
Control outputs:	DC	DC			V1	V2				V1	V2		
	DC	On/Off			V2	V1							
	On/Off	DC			V1		V2	✓	✓				
	On/Off	On/Off			V1	V2							

Application	Equipment		Terminals					Terminals					
	V1	V2											
2-pipe with electric heater	YHC	YE											
Control outputs:	DC	DC			V1	V2				V1	V2		
	DC	On/Off			V2	V1							
	On/Off	DC			V1		V2	✓	✓				
	On/Off	On/Off			V1	V2							

Application	Equipment			Terminals					Terminals				
	V1	V2	V3										
4-pipe with electric heater	YH	YC	YE										
Control outputs:	DC	DC	DC			V1	V2	V3			V1	V2	V3
	DC	DC	On/Off			V3	V1	V2	✓	✓			

Application	Equipment				Terminals					Terminals						
	V1	V2	V3	V4												
4-pipe/2-stage	YH1	YC1	YH2	YC2												
Control outputs:	DC	DC	DC	DC			V4	V1	V2	V3	✓	✓	V1	V2	V3	V4

N1	Room thermostat RDG26..KN	M1	1-speed or 3-speed fan, DC 0...10 V fan
S1, S2, S3	Switch (keycard, window contact, presence detector etc.)	V1, V2, V3, V4	Valves actuators: On/Off or DC 0...10 V, heating, cooling, radiator, heating/cooling, 1 st or 2 nd stage
YE	Electric heater	B1, B2, B3	Temperature sensor (return air temperature, external room temperature, changeover sensor, etc.)
YH	Heating valve actuator	YHC	Heating/cooling valve actuator
YC	Cooling valve actuator	YR	Radiator valve actuator
CE+	KNX data +	YHC1/YH1/YH2/	1 st /2 nd stage
CE-	KNX data -	YHC2/YC1/YC2	

RDG26..KN		
Application	4-pipe with 6-port PICV	
DC 0...10 V fan		
1-speed/3-speed fan		
Application	4-pipe with 6-port ball valve as changeover and PICV	Chilled/heated ceiling with 6-port control ball valve

N2	Room thermostat RDG26..KN	V3	6-port modulating control actuator
S1, S2, S3	Switch (keycard, window contact, presence detector etc.)	V4	PICV control valve
B1, B2, B3	Temperature sensor (return air temperature, external room temperature, changeover sensor, etc.)	M1	1-speed or 3-speed fan, DC 0...10 V fan
CE-	KNX data -	CE+	KNX data +

Note: In application "4-pipe with 6-port ball valve as changeover and PICV", Y50 can be connected with a DC 0...10 V fan.

IAQ – CO₂ connection diagrams

The fresh air damper (DC or On/Off) can be controlled via KNX S-Mode objects or directly connected to the thermostat as follows:

- DC damper is connected to terminal U1
- ON/Off damper is connected to terminal Q3 (relay output).

Exception:

RDG204KN, for applications with 3-speed fan: terminal Y4 (triac output)

RDG204KN fan coil and universal (CLC, with no fan) applications with IAQ control:

FCU application	CLC app ³⁾	Fan ¹⁾		H/C Control outputs signal combination	Damper signal ²⁾	
		DC	3-speed		DC	On/Off
2-pipe	✓	✓		<ul style="list-style-type: none"> • On/Off (PWM) • 3-pos 	✓	✓
	✓		✓		✓	✓
2-pipe+ RAD 2-pipe+ el. heat 2-pipe/2-stage 4-pipe	✓	✓		<ul style="list-style-type: none"> • 2 × On/Off (PWM) • On/Off (PWM) + 3-pos • 3-pos + On/Off (PWM) • 2 × 3-pos 	✓	✓
	✓		✓		✓	
	✓		✓		<ul style="list-style-type: none"> • 2 × On/Off (PWM) • 3-pos + On/Off (PWM) 	
4-pipe+ el. heater	✓	✓		<ul style="list-style-type: none"> • 3 × On/Off (PWM) • On/Off (PWM) + 3-pos + On/Off (PWM) 	✓	✓
	✓		✓		✓	
	✓		✓		<ul style="list-style-type: none"> • 3 × On/Off (PWM) 	
4-pipe/2-stage	✓	✓		<ul style="list-style-type: none"> • 4 × On/Off (PWM) 	✓	✓
	✓		✓		✓	

RDG264KN fan coil and universal (CLC) applications with IAQ control:

FCU application	CLC app ³⁾	Fan ¹⁾		H/C Control outputs signal combination	Damper signal ²⁾	
		DC	3-speed		DC	On/Off
2-pipe	✓	✓		<ul style="list-style-type: none"> • On/Off • DC 	✓	✓
	✓		✓		✓	
2-pipe+ RAD 2-pipe+ el. heat 2-pipe/2-stage 4-pipe	✓	✓		<ul style="list-style-type: none"> • 2 × On/Off • On/Off + DC • DC + On/Off • 2 × DC 	✓	✓
	✓		✓		✓	
	✓		✓		<ul style="list-style-type: none"> • 3 × DC • On/Off + 2 × DC 	✓
4-pipe+ el. heater	✓	✓		<ul style="list-style-type: none"> • 3 × DC • On/Off + 2 × DC 	✓	✓
	✓		✓		✓	
4-pipe/2-stage	✓	✓		<ul style="list-style-type: none"> • 4 × DC 		✓
4-pipe with 6-port ball valve	✓			<ul style="list-style-type: none"> • DC 	✓	✓
4-pipe with PICV + 6-port valve as changeover	✓	✓		<ul style="list-style-type: none"> • On/Off + DC 	✓	✓

¹⁾ Selectable via P351 (Fan speeds)

²⁾ Selectable via P453 (Indoor air quality damper)

³⁾ Universal (CLC) applications can be set by switching off the fan functions (P350 = 0)

Note for IAQ control on universal (CLC) heating and cooling systems.

Application can be set as per Applications for universal systems [→ 6] and by switching off the fan function (P350 = 0).

On applications without fan control, the thermostat controls the position of the damper when the IAQ setpoint P023 is exceeded. An independent fresh air system guarantees fresh air flow to the room.

See the possible combinations of applications, control signals and damper types in the above table for RDG204KN and RDG264KN.

Frost protection function is not available on universal applications.

Dimensions

RDG2..KN

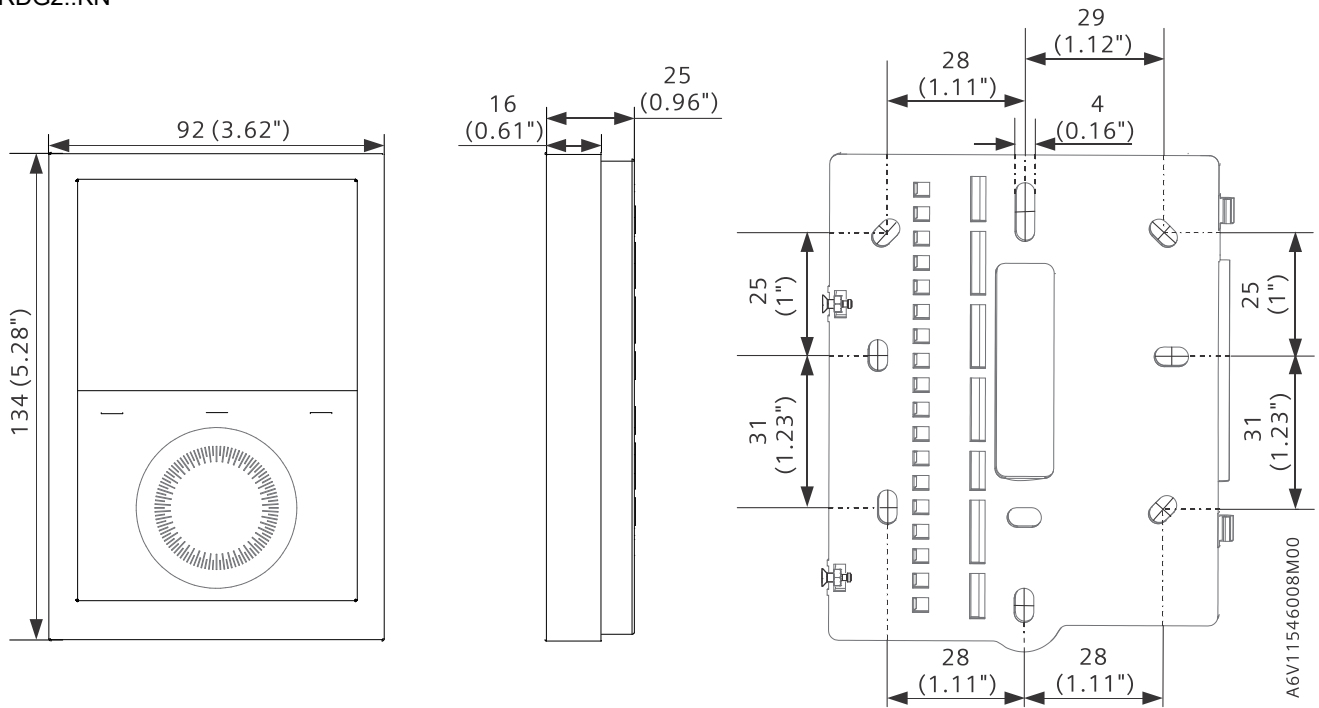

ARG200

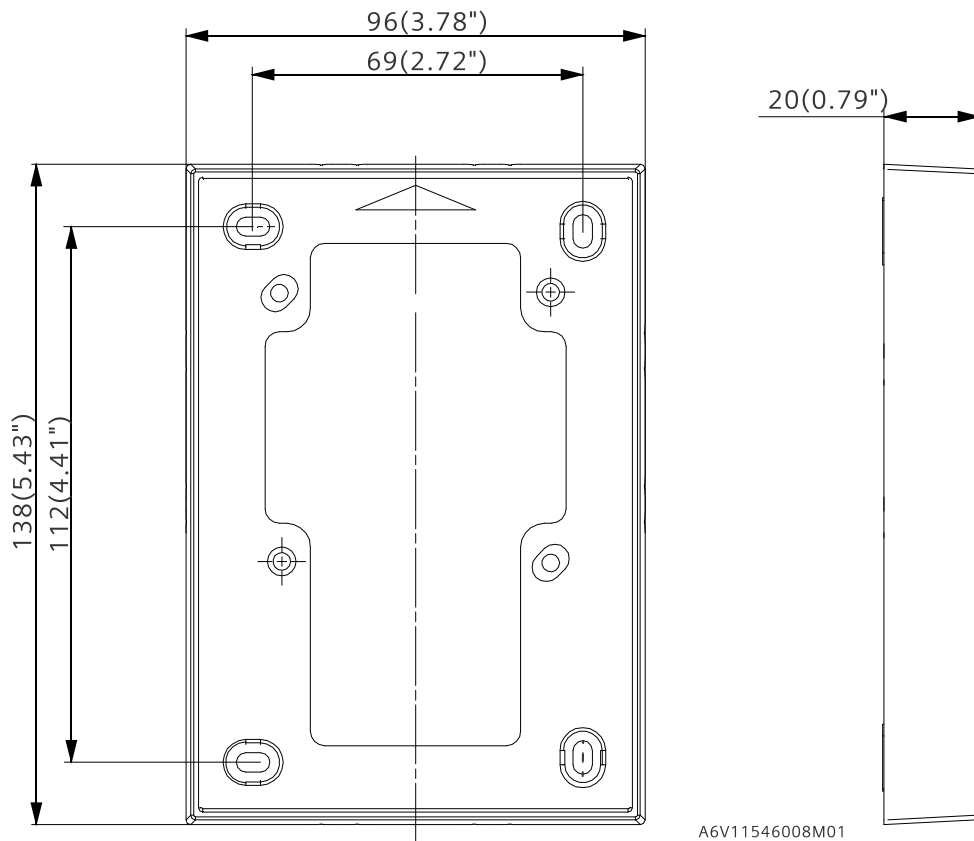

Dimensions in mm (inch)

Issued by
Siemens Switzerland Ltd
Smart Infrastructure
Global Headquarters
Theilerstrasse 1a
CH-6300 Zug
+41 58 724 2424
www.siemens.com/buildingtechnologies

© Siemens Switzerland Ltd, 2020
Technical specifications and availability subject to change without notice.

Document ID A6V11545853_en--_d
Edition 2023-02-14