



RDF302, RDF302.B



RDF302/VB

Flush-mounted room thermostats with RS485 Modbus communications

RDF302

RDF302.B

RDF302/VB

For 2-pipe, 2-pipe with electrical heater, and 4-pipe fan coil units
For use with compressors in DX type equipment

- AC 230 V operating voltage
- Large display with Backlight
- On/off or 3-position control
- Automatic or manual fan speed control
- 1-speed or 3-speed fan selection
- Operating modes: Comfort, Economy and Protection
- Control depending on the room or the return air temperature
- Automatic or manual heating/cooling changeover
- Minimum and maximum limitation of room temperature setpoint
- Commissioning and control parameters via local HMI or RS485 Modbus
- RS485 communicative interface in Modbus RTU slave mode
- Mounting on recessed square conduit box, 60.3 mm fixing centers
- User and parameter settings can be retained or restored with power loss

RDF302 & RDF302/VB Only

- 2 multifunctional inputs for keycard contact, external sensor, etc.

Use

Room temperature control (heating or cooling) in individual rooms and zones by means of:

2-pipe fan coil units

2-pipe fan coil units with electrical heater

4-pipe fan coil units

Compressors in DX-type equipment

Compressors in DX-type equipment with electrical heater

The RDF302, RDF302/VB and RDF302.B controls:

One single or 3-speed fan

One or two on/off valve actuators

One on/off valve actuator and one 1-stage electrical heater

One 3-position valve actuator

One 1-stage compressor in DX-type equipment, or one 1-stage compressor with electrical heater

Used in systems with:

Heating or cooling mode

Automatic heating/cooling changeover

Manual heating/cooling changeover

Heating and cooling mode (e.g. 4-pipe system)

The room thermostats are delivered with a fixed set of applications.

The relevant application is selected and activated during commissioning using one of the following tools:

Local DIP switch and HMI

Modbus commissioning tools

Functions

Maintain room temperature via built-in temperature sensor or external room temperature/return air temperature sensor

Changeover between heating and cooling mode (automatic changeover via local sensor/bus or manual changeover)

Select application via DIP switches or commissioning tools

Select operating mode via operating mode button on the thermostat

Single speed or 3-speed fan control (automatic or manual)

Display current room temperature or setpoint in °C and/or °F

Minimum and maximum limitation of room temperature setpoint

Key lock (automatic, manual or via bus)

Two multifunctional inputs, freely selectable for:

- Operating mode switchover contact (keycard)
- Automatic heating/cooling changeover sensor
- External room temperature sensor or return air temperature sensor
- Dew point sensor
- Electrical heater enabled
- Fault input
- Monitor input for temperature sensor or switch status

Advanced fan control function, e.g. fan kick, fan start, selectable fan operation (enable, disable or depending on heating or cooling mode)

Purge function together with 2-port valve in a 2-pipe changeover system

Reminder to clean filters

Floor heating temperature limit
Reload factory settings for commissioning and control parameters
RS 485 Modbus (terminals +, - and REF) for communication with Modbus compatible devices
Display of outdoor temperature or time of day via Modbus

Applications

The thermostats support the following applications, which can be configured using the DIP switches inside the front panel of the unit or a Modbus commissioning tool.

Remote configuration

All DIP switches need to be set to **OFF** (factory setting) to select an application via commissioning tool.

Remote configuration , via commissioning tool (factory setting)	DIP switches 
--	--

Applications for fan coil systems *)

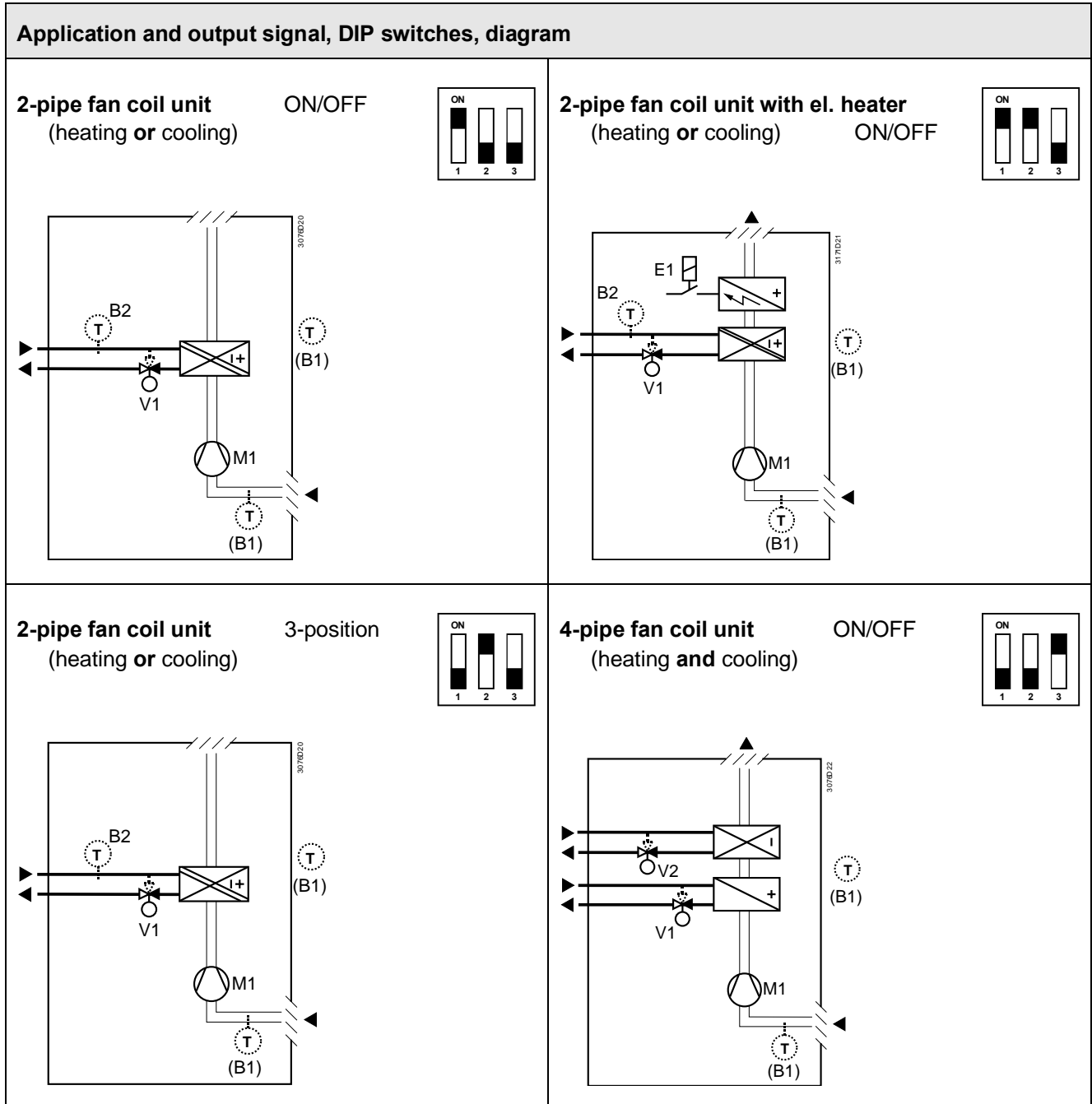

V1 Heating or heating / cooling valve actuator

V2 Cooling valve actuator

E1 Electric heater

B1 Return air temperature sensor or external room temperature sensor (optional)

B2 Changeover sensor (optional)

M1 3- or 1-speed fan

*) RDF302.B does not have inputs X1 and X2, so sensor B1 and B2 are not included in RDF302.B application.

Applications for Universal systems *)

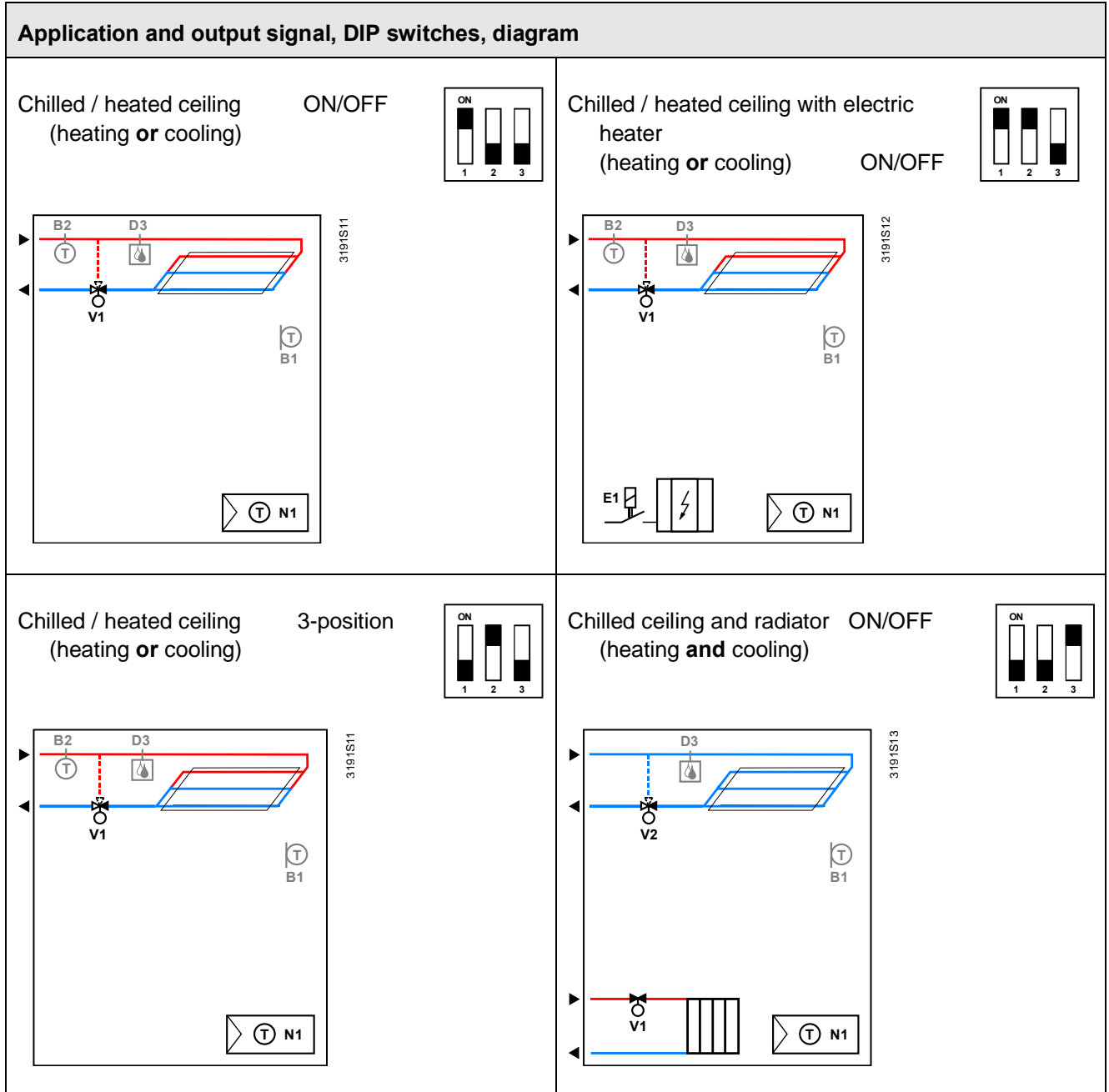

V1 Heating or heating / cooling valve actuator

B1 Return air temperature sensor or external room temperature sensor (optional)

V2 Cooling valve actuator

B2 Changeover sensor (optional)

E1 Electric heater

D3 Dewpoint sensor

*) RDF302.B does not have inputs X1 and X2, so sensor B1 and B2 are not included in RDF302.B application.

Applications for heat pump systems *)

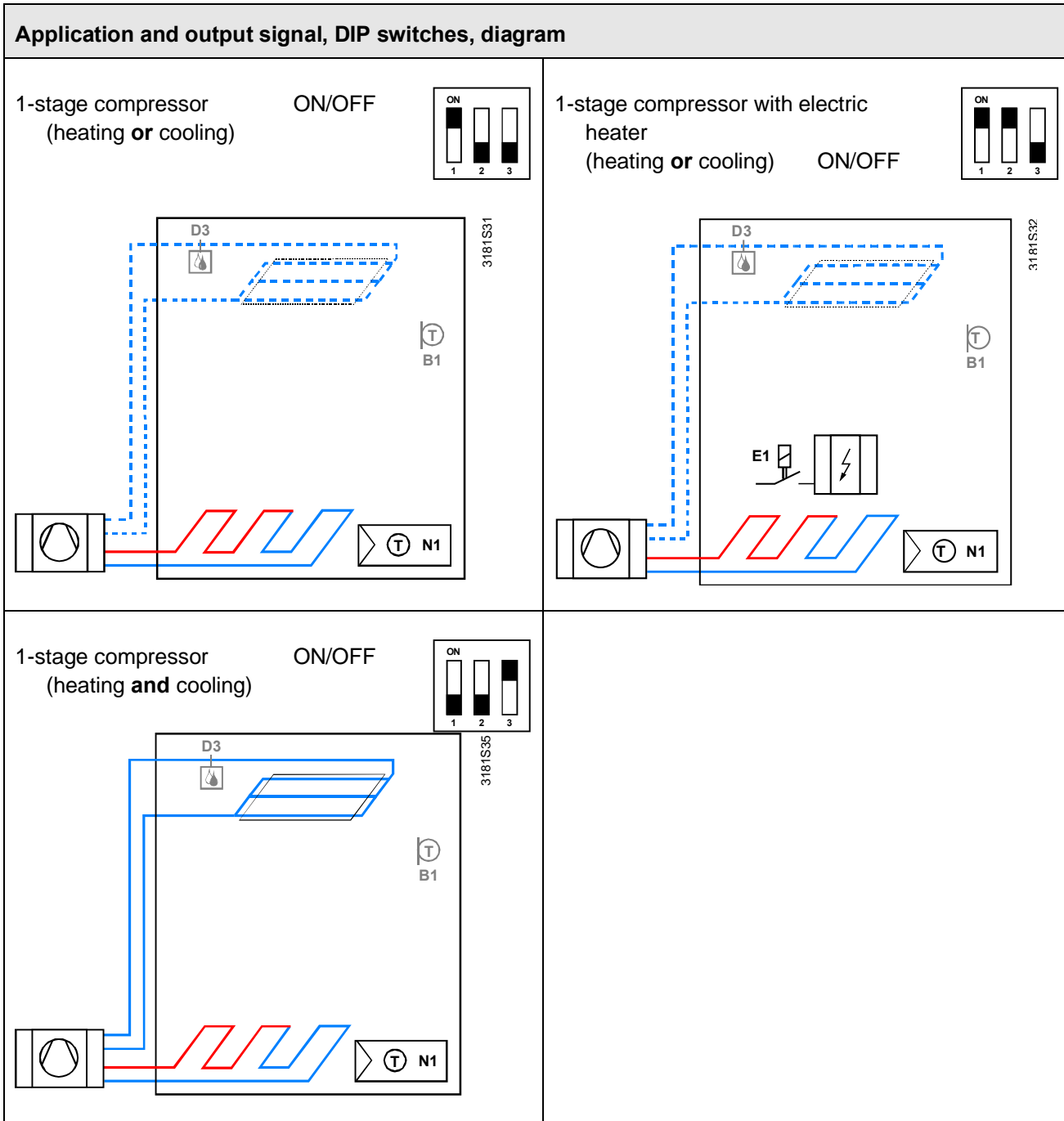

N1 Thermostat
 Terminal Y11: Heating (H&C) or Heating/Cooling
 Terminal Y21: Cooling (H&C)

E1 Electric heater

B1 Return air temperature sensor or external room temperature sensor (optional)

D3 Dewpoint sensor

*) RDF302.B does not have inputs X1 and X2, so sensor B1 and B2 are not included in RDF302.B application.

Type summary

Product number	Stock number	Operating voltage	Control outputs		Suitable conduit box	Color
			3-pos	ON/OFF		
RDF302	S55770-T238	AC 230 V	1 ¹⁾	2 ¹⁾	square	White
RDF302/VB	S55770-T428	AC 230 V	1 ¹⁾	2 ¹⁾	square	Black
RDF302.B	S55770-T416	AC 230 V	1 ¹⁾	2 ¹⁾	square	White













¹⁾ Selectable: ON/OFF or 3-position

For input and output difference between RDF302, RDF302/VB and RDF302.B, see page 15.

Ordering

- When ordering, indicate both product number / SSN number and name:
E.g. **RDF302 / S55770-T238 Modbus room thermostat**
- Order valve actuators separately.

Equipment combinations



	Description		Product no.	Data sheet
	Cable temperature sensor or changeover sensor, cable length 2.5 m NTC (3 kΩ at 25 °C)		QAH11.1	1840
	Room temperature sensor NTC (3 kΩ at 25 °C)		QAA32	1747
	Cable temperature sensor cable length 4 m NTC (3 kΩ at 25 °C)		QAP1030/UFH	1854
	Condensation monitor / Dew point monitor		QXA2601 / QXA2602 / QXA2603 / AQX2604	3302
ON / OFF actuators	Electromotoric ON / OFF actuator		SFA21...	4863
	Electromotoric ON / OFF valve and actuator (only available in AP, UAE, SA and IN)		MVI... / MXI...	A6V112 51892
	Zone valve actuator (only available in AP, UAE, SA and IN)		SUA...	4832
	Thermal actuator (for radiator valves)		STA23...	4884
	Thermal actuator (for small valves 2.5 mm)		STP23...	4884
3-position actuators	Electrical actuator, 3-position (for radiator valves)		SSA31...	4893
	Electrical actuator, 3-position (for 2- and 3-port valves / V...P45)		SSC31...	4895
	Electrical actuator, 3-position (for small valves 2.5 mm)		SSP31...	4864
	Electrical actuator, 3-position (for small valves 5.5 mm)		SSB31...	4891

Electrical actuator, 3-position (for small valves 5.5 mm)		SSD31...	4861
Electromotoric actuator, 3-position (for small valves 5.5 mm)		SQS35...	4573

Note: For the maximal number of actuators in parallel, refer to information in the data sheets of the selected actuators and to this list, depending on which value is lower:

- Parallel operation of max 6 SS... actuators (3-pos) is possible.
- Parallel operation of max 10 ON / OFF actuators is possible.
- Parallel operation of SQS35 is not possible.

Accessories

Description		Product no. / SSN	Data sheet
Changeover mounting kit (50 pcs / package)		ARG86.3	N3009
Plastic mounting spacer for flush mount thermostats to increase the headroom in the conduit box by 10 mm		ARG70.3	N3009

Mechanical design

The thermostats consist of 2 parts:

Front panel with electronics, operating elements and built-in room temperature sensor.

Mounting base with power electronics.

The rear of the mounting base contains the screw terminals.

The base fits on a square conduit box with 60.3 mm fixing centers.

Slide the front panel in the mounting base and snap on.

Operation and settings

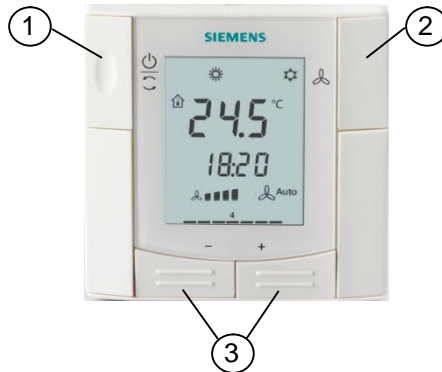

RDF302, RDF302/VB, RDF302.B

- 1 Operating mode selector
- 2 Change fan operation
- 3 Adjust setpoints and control parameters

Display

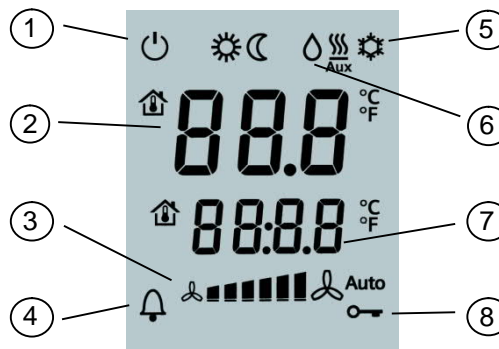

- | | |
|---|---|
| <ol style="list-style-type: none"> 1 Operating mode
 <ul style="list-style-type: none"> ☰ Protection ☀ Comfort ☾ Economy 2 Displays room temperature, setpoints and control parameters
 <ul style="list-style-type: none"> 🏠 Symbol indicates current room temperature 3 Fan mode
 <ul style="list-style-type: none"> 🌀 Auto Auto fan active 🌀 📊 🌀 Fan speed low, medium, high 4 🔔 Indicates fault or reminder | <ol style="list-style-type: none"> 5 Heating/cooling mode
 <ul style="list-style-type: none"> ☀ Cooling ☀ Heating ☀ Aux Electrical heater active 6 💧 Condensation in room (dew point sensor active) 7 Additional user information, like outdoor temperature (🏠) or time from Modbus (selectable via parameters) 8 🔑 Key lock active |
|---|---|

Engineering notes

Device address The device address of each RDF302... was assigned to "1" (factory setting). If necessary, engineer/installer can change the address value through the parameter P81.

Baud rate The Baud rate is selectable. Four options, 4800 bps, 9600 bps, 19200 bps and 38400 bps, are available for the RDF302... adapting into the Modbus network (19200 bps is default).

Parity The parity can be set to none, odd or even (even is default).

Note: Once you made any changes on the baud rate or parity, you must reset the power before the changes become effective. To reset the power, you can consider by opening the front panel out of the mounting plate and snap it back.

Mounting and installation

Mount the room thermostat on a recessed square conduit box with 60.3 mm fixing centers. Do not mount on a wall in niches or bookshelves, behind curtains, above or near heat sources, or exposed to direct solar radiation. Mount about 1.5 m above the floor.

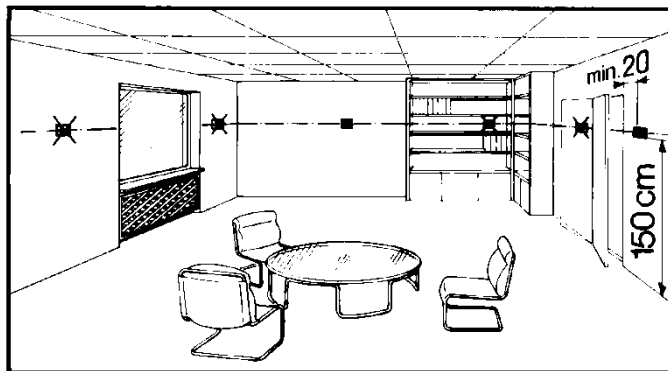

Mounting  Mount the room thermostat in a clean, dry indoor place without direct airflow from a heating / cooling device, and not exposed to dripping or splash water. In case of limited space in the conduit box, use mounting bracket ARG70.3 to increase the headroom by 10 mm.

Wiring See Mounting Instructions M3079 enclosed with the thermostat.



Comply with local regulations to wire, protection and earth the thermostat. The device has no internal fuse for supply lines to fan and actuators. To avoid risk of fire and injury due to short-circuits, the AC 230 V mains supply line must have a circuit breaker with a rated current of no more than 10 A.



Properly size the cables to the thermostat, fan and valve actuators for AC 230 V mains voltage.



Use only valve actuators rated for AC 230 V.

The wiring cross section used for power supply (L, N), fan/relays (Qx) and 230 V outputs (Yx -N) must be adapted to the preceding overload protection elements (max 10A) under all circumstances. Comply under all circumstances with local regulations.



Cables of SELV inputs X1-M / X2-M: Use cables with min 230 V insulation, as the conduit box carries AC 230 V mains voltage.

Inputs X1-M or X2-M: Several switches (e.g. summer / winter switch) may be connected in parallel. Consider overall maximum contact sensing current for switch rating.



Isolate the cables of Modbus communication input +, - and REF for 230 V.

No cables provided with a metal sheild.

Disconnect from supply before opening the cover.

Commissioning notes

Applications

The room thermostats are delivered with a fixed set of applications.

Select and activate the relevant application during commissioning using one of the following tools:

- Local DIP switch and HMI
- Modbus commissioning tools

Set the DIP switches before snapping the front panel to the mounting plate, if you want to select an application via **DIP switches**.

All DIP switches need to be set to “OFF” ("remote configuration"), if you want to select an application via **commissioning tools**.

After power is applied, the thermostat resets and all LCD segments flash, indicating that the reset was correct. After the reset, which takes about 3 seconds, the thermostat is ready for commissioning by qualified HVAC staff.

RDF302.B does not have input X1 and X2.

Display “NONE”

If the “NONE” displays on the LCD, it means that the DIP switches was set to OFF-OFF for remote configuration, but the application had not yet assigned to the device. The application can be set by commissioning tools via the RS485 Modbus.



Note

Each time the application is changed, the thermostat reloads the factory setting for all control parameters, except for baud rate (P68), parity (P70) and zone addresses (P81)!

Control parameters

The thermostat's control parameters can be set to ensure optimum performance of the entire system.

The parameters can be adjusted using

- Local HMI
- Modbus commissioning tools

Control sequence

The control sequence may need to be set via parameter P01 depending on the application. The factory setting for the 2-pipe application is “Cooling only”; and “Heating and Cooling” for the 4-pipe application.

Compressor-based application



When the thermostat is used with a compressor, adjust the minimum output on-time (parameter P48) and off-time (parameter P49) for Y11/Y21 to avoid damaging the compressor or shortening its life due to frequent switching.

Calibrate sensor

Recalibrate the temperature sensor if the room temperature displayed on the thermostat does not match the room temperature measured (after minimum 1 hour of operation). To do this, change parameter P05.

Setpoint and range limitation

We recommend to review the setpoints and setpoint ranges (parameters P08...P12) and change them as needed to achieve maximum comfort and save energy.



Disposal



The device is considered electrical and electronic equipment for disposal in terms of the applicable European Directive and may not be disposed of as domestic garbage.

- Dispose of the device through channels provided for this purpose.
- Comply with all local and currently applicable laws and regulations.

Technical data

Power supply	Rated voltage	AC 230 V
	Frequency	50/60 Hz
	Power consumption	Max. 7 VA / 3.7 W
Caution 	No internal fuse!	
	External preliminary protection with max C 10 A circuit breaker required in all cases.	
Outputs	Fan control Q1, Q2, Q3-N	AC 230 V
	Rating	5 mA...5(2) A
Note! 	Fans must NOT be connected in parallel!	
	Connect one fan directly, for additional fans, one relay for each speed.	
	Control output Y11-N / Y21-N (N.O.)	AC 230 V
Caution 	Rating	Max. 5(2) A
	No internal fuse!	
	External preliminary protection with max C 10 A circuit breakers in the supply line required in all cases.	
Inputs	Multifunctional input X1-M / X2-M **)	
	Temperature sensor input:	
	Type	NTC (3 kΩ at 25 °C)
	Temperature range	0...49 °C
	Cable length	Max. 80 m
	Digital input:	
	Operating action	Selectable (NO / NC)
	Contact sensing	SELV DC 0...5 V / max 5 mA
	Parallel connection of several thermostats for one switch	Max. 20 thermostats per switch
	Insulation against mains voltage (SELV)	4 kV, reinforced insulation
Function of inputs: Selectable		
External temperature sensor, heating/cooling changeover sensor, operating mode switch-over contact, dew point monitor contact, enable electrical heater contact, fault contact, monitoring input	X1: P38 X2: P40	
Modbus	Interface type	
	RS485 Modbus RTU, Wire (ref.): 16 AWG, 1 pair, shielded serial line with 1.5 mm ² and length < 1200 m	
	Bus current	Max. 50 mA
	Modbus topology: See Modbus manual (MODBUS over serial line specification and implementation guide from http://www.modbus.org).	

Operational data	Switching differential, adjustable	
	Heating mode (P30)	2 K (0.5...6 K)
	Cooling mode (P31)	1 K (0.5...6 K)
	Setpoint setting and range	
	☀ Comfort (P08)	21 °C (5...40 °C)
	☺ Economy (P11-P12)	15 °C / 30 °C (OFF, 5...40 °C)
	⏸ Protection (P11-P12)	8 °C / OFF (OFF, 5...40 °C)
	Multifunctional input X1/X2 **)	Selectable 0...8
	Input X1 default value (P38)	3 (Op. Mode switchover)
	Input X2 default value (P40)	1 (External temp. sensor)
	Built-in room temperature sensor	
	Measuring range	0...49 °C
	Accuracy at 25 °C	< ± 0.5 K
	Temperature calibration range	± 3.0 K
	Settings and display resolution	
Setpoints	0.5 °C	
Current temperature value displayed	0.5 °C	
Environmental conditions	Storage	As per IEC 60721-3-1
	Climatic conditions	Class 1K3
	Transport	As per IEC 60721-3-2
	Climatic conditions	Class 2K3
Operation	As per IEC 60721-3-3	
	Climatic conditions	Class 3K5 ¹⁾
Standards and directives	EU Conformity (CE)	CE1T3079xx *)
	RCM	A5W90002895 *)
	Safety class	II as per EN 60730-1
	Pollution class	Normal
	Degree of protection of housing	IP 30 as per EN 60529
	Housing flammability class according to UL94	V-0
Environmental compatibility	The product environmental declaration CE1E3079en (RDF302) *, A5W00085839A (RDF302/VB) *, A6V11610192 (RDF302.B) *) contains data on environmentally compatible product design and assessments (RoHS compliance, materials composition, packaging, environmental benefit, disposal).	
General	Connection terminals	Solid wires or prepared stranded wires 1 x 0.4...1.5 mm ²
	Housing front color	RAL 9003 white RAL 9004 black
	Weight without / with packaging	0.174 kg/0.261 kg

*) The documents can be downloaded from <http://siemens.com/bt/download>.

**) RDF302.B does not have inputs X1 and X2. Parameters related to X1 and X2 input functions are not applicable to RDF302.B.

¹⁾ No condensation is allowed.

Connection terminals

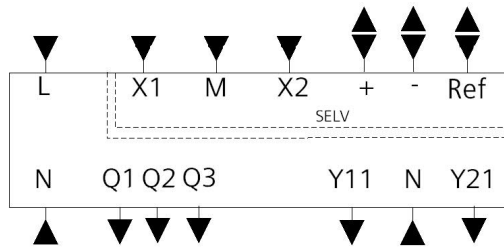

L, N	Operating voltage AC 230 V
Q1	Control output "Fan speed 1 AC 230 V"
Q2	Control output "Fan speed 2 AC 230 V"
Q3	Control output "Fan speed 3 AC 230 V"
Y11, Y21	Control output "Valve" AC 230 V (N.O., for normally closed valves), output for compressor or output for electrical heater
X1, X2 ¹⁾	Multifunctional input for temperature sensor (e.g. QAH11.1) or potential-free switch Factory setting: X1 = Operating mode switchover contact X2 = External sensor (function can be selected via parameter P38/P40).
M ¹⁾	Measuring neutral for sensor and switch
+	RS485 Modbus connection
-	RS485 Modbus connection
REF	RS485 signal / common ground (Differential common)

¹⁾ RDF302.B does not have inputs X1, X2 and M.

Connection diagrams

Application

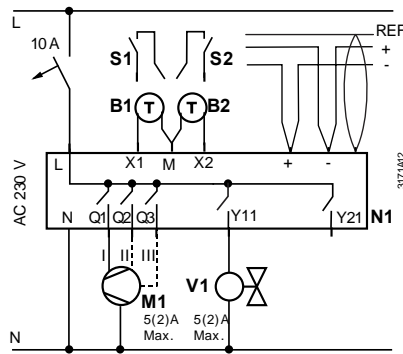

2-pipe, 2-position

2-pipe, 3-position

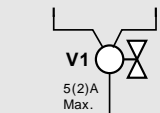

2-pipe & electric heater

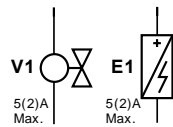

4-pipe

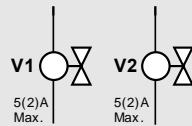

1-stage compressor (heating and/or cooling)

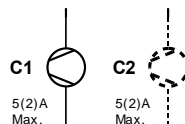

1-stage compressor & electric heater

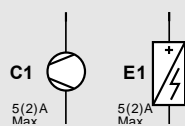

N1	Room thermostat RDF302...
M1	1- or 3-speed fan
V1	Valve actuator, 2- or 3-position
V1, V2	Valve actuator, 2-position
E1	Electric heater
C1, C2	1-stage compressor
S1, S2	Switch (keycard, window contact, presence detector, etc.)
B1, B2	Temperature sensor (return air temperature, external room temperature, changeover sensor, etc.)
+	RS485 Modbus connection
-	RS485 Modbus connection
REF	RS485 signal/common ground (Differential common)
RDF302.B does not have inputs X1, X2 and M.	

Dimensions (mm)

