



Room Temperature Sensors

QAA20...

- Passive sensors for acquiring the temperature in rooms.
- Range of use 0...50 °C / <85 % r. h.

Use

In heating, ventilation and air conditioning plants for acquiring the room temperature.

Type summary

<i>Type reference</i>	<i>Sensing element</i>	<i>Range of use</i>	<i>Time constant</i>
QAA2010	Pt 100	0...50 °C	Approx. 7 min
QAA2012	Pt 1000	0...50 °C	Approx. 7 min
QAA2030	NTC 10k	0...50 °C	Approx. 7 min

Ordering

When ordering, please give name and type reference, e.g.:
Room temperature sensor **QAA2010**

Equipment combinations

The room temperature sensors are suited for use with all types of controllers that can handle analog, passive sensor signals.

The sensor acquires the room temperature via its sensing element.
 The resistance of the sensing element changes as a function of the ambient temperature. The resistance value is used for further handling by a suitable controller.

Sensing element

Pt 100 (class B)

Characteristic:

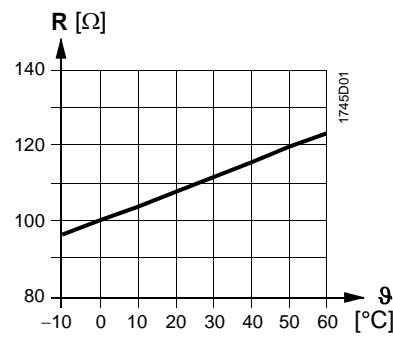

Accuracy:

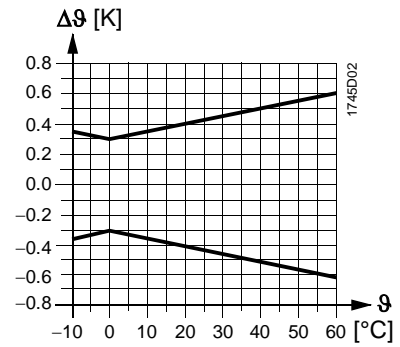

Pt 1000 (class B)

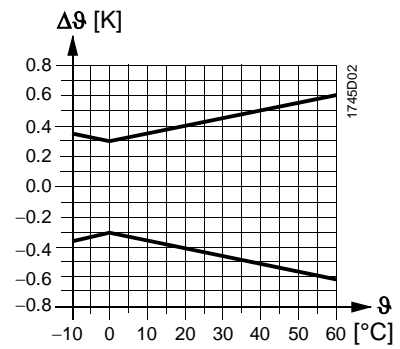
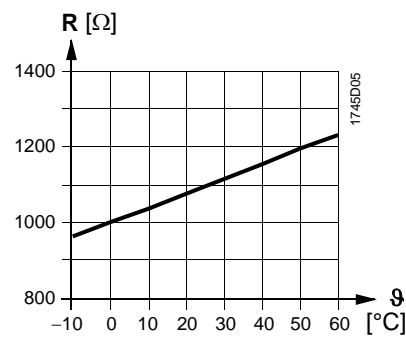

NTC 10k

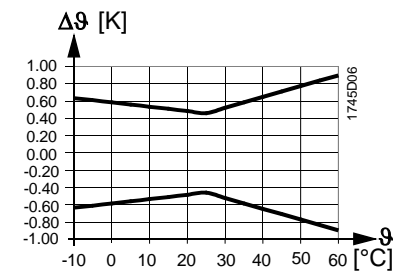
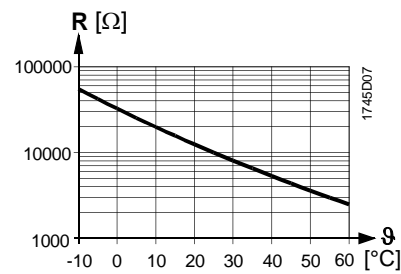

Legend

- R Resistance in Ohm
- θ Temperature in degrees Celsius
- Δθ Temperature differential in Kelvin

Mechanical design

The units have been designed for wall mounting. They are suited for use with most types of commercially available recessed conduit boxes. The cables can be introduced from the rear (concealed wiring) or from below or above (surface-run wires) through knock-out openings.

The units consist of 2 major sections: Housing and base. Both snap together but can be detached again. The base carries the connection terminals.

Disposal



The devices are considered electronics devices for disposal in terms of European Directive 2012/19/EU and may not be disposed of as domestic waste.

- Dispose of the device via the channels provided for this purpose.
- Comply with all local and currently applicable laws and regulations.

Engineering notes

The permissible cable lengths are dependent on the type of controller with which the sensor is used. They are specified in the Data Sheet of the relevant controller.

Mounting notes

Location: On an inner wall of the space to be heated or air conditioned. Not in recesses, shelves, not behind curtains, not opposite or near heat sources. The unit must not be exposed to direct solar radiation.

The end of the conduit at the sensor must be sealed to prevent false measurements due to drafts through the conduit.

The permissible ambient conditions should be observed.

Installation Instructions are printed on the packaging.

Technical data

Functional data	Range of use	refer to "Type summary"
	Sensing element	refer to "Type summary"
	Time constant	refer to "Type summary"
	Measuring accuracy	refer to "Function"
	Type of measurement and output	passive
Degree of protection	Safety class	III according to EN 60730-1
	Protection degree of housing	IP30 according to EN 60529
Electrical connections	Screw terminals for	2 x 1.5 mm ² or 1 x 2.5 mm ²
	Perm. cable lengths	refer to "Engineering notes"
Environmental conditions	Operation	to IEC 60721-3-3
	Climatic condition	class 3K5
	Temperature	0...50 °C
	Humidity	<85 % r. h.

Transport	to IEC 60721-3-2
Climatic condition	class 2K3
Temperature	-25...+65 °C
Humidity	<95 % r. h.
Mechanical environmental conditions	class 2M2

Directives and Standards	Product standard	EN 60730-1 Automatic electrical controls for household and similar use
	EU Conformity (CE)	8000073890 ^{*)}
	UL	UL873 http://ul.com/database
Environmental compatibility	The product environmental declaration CE1E1701 ^{*)} contains data on environmentally compatible product design and assessments (RoHS compliance, materials composition, packaging, environmental benefit, disposal).	
Materials and colors	Housing front	ASA+PC, NCS S 0502-G (white)
	Bottom	ASA+PC, NCS 2801-Y43R (grey)
	Base	PC, NCS 2801-Y43R (grey)
	Packaging	corrugated cardboard
	Sensor (complete assembly)	silicone-free
Weight	Incl. packaging	Ca. 0,1 kg

*) The documents can be downloaded from <http://siemens.com/bt/download>.

Internal diagram

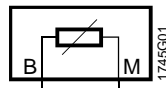

The internal diagram is identical for all types of room temperature sensors covered by this Data Sheet.

The connecting wires are interchangeable.

Dimensions

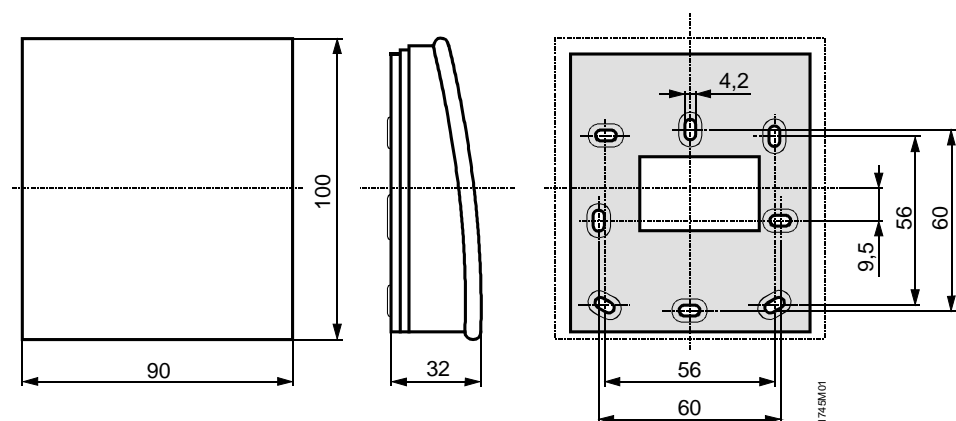

Dimensions in mm