

ACVATIX™

Rotary actuators for ball valves

GLD161.9E



**Electromotoric rotary actuators for modulating control.
Used in heating, ventilation and air conditioning plants.**

- For 2-port and 3-port control ball valves, internally threaded connections (VAI61.. and VBI61..) or externally threaded connections (VAG61.. and VBG61..), DN15 to DN50
- Nominal torque 8 Nm
- Operating voltage AC 24 V ~ / DC 24...48 V =
- Pre-wired with 0.9 m long connection cables

- Brushless, robust DC motors ensure reliable operation regardless of load.
- The rotary actuators do not require an end position switch, are overload proof, and remain in place upon reaching the end stop.
- The gears are maintenance free and low noise.
- Suitable for use with modulating controllers (DC 0/2...10 V).

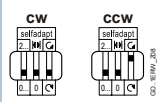
Function	Description
Control type	Modulating control (0/2...10 V)
Rotary direction	<p>Clockwise or counter-clockwise direction depends ...</p> <p>... on the setting of the rotary direction DIL switch</p>  <p>... on the positioning signal.</p> <p>The actuator remains in the achieved position:</p> <p>... if the control signal is maintained at a constant value</p> <p>... for loss of operating voltage.</p> <p>NC (normally closed) ball valve</p> <p>DIL 3 set to "counter-clockwise" (ccw)</p> <p>Flow = 0% at Y = 0 V</p> <p>Flow = 100% at Y = 10 V</p> <p>NO (normally open) ball valve</p> <p>DIL 3 set to "clockwise" (cw)</p> <p>Flow = 100% at Y = 0 V</p> <p>Flow = 0% at Y = 10 V</p>
Position indication: Mechanical	Rotary angle position indication by a position indicator/hand lever.
Position indication: Electrical	Output voltage U = DC 0/2...10 V is generated proportional to the rotary angle. U depends on the rotary direction of the DIL switch setting.
Self-adaptation of linear span	When self-adaptation is active, the actuator automatically determines the mechanical end positions of the linear span.
Manual adjustment	The rotary actuator can be manually adjusted by pressing the gear train disengagement button.
Rotary angle limitation	The rotary angle of the shaft adapter can be limited mechanically with a set screw.

Housing

The housing consists essentially of flame retardant, non brominated, non chlorinated glass fibre reinforced plastic.

Type	Stock no.	Control	Operating voltage	Positioning signal Y	Position indicator U = DC 0...10 V \equiv	Self-adaption of rotational angle range	Aux. switches	Rotary direction switch
GLD161.9E	S55499-D278	Modulating	AC 24 V ~ / DC 24...48 V \equiv	DC 0/2...10 V \equiv	yes	yes	–	yes

Accessories / Spare parts

Individual spare parts are not available. Components of the accessory kit ASK77.3 ¹⁾, available as an accessory, can however be used for spare parts.

Description	Components
ASK77.3 Accessory Kit BV for GLBxx1.9E	Mounting bracket (base plate) Axle with sleeve and spring Manual lever with locking clip

¹⁾ Can also be used as rotary actuator for ball valves together with the actuator for air dampers G..B.1E.

Equipment combinations

GLD161.9E and VA..61.. 2-port control ball valves

Control ball valves with:						GLD161.9E		
internal threads ¹⁾	Rp	external threads ²⁾	G..B	k _{vs} [m ³ /h]	DN	Δp_{\max}	Δp_s	
–	–	VAG61.15..	G 1 B	1...6.3	15	350	1400	
VAI61.15..	Rp ½"	–	–	1...10	15			
VAI61.20..	Rp ¾"	VAG61.20..	G 1 ¼ B	4...10	20			
VAI61.25..	Rp 1"	VAG61.25..	G 1 ½ B	6.3...16	25			
VAI61.32..	Rp 1¼"	VAG61.32..	G 2 B	10...25	32			1000
VAI61.40..	Rp 1½"	VAG61.40..	G 2 ¼ B	16...40	40			800
VAI61.50..	Rp 2"	VAG61.50..	G 2 ¾ B	25...63	50			600

GLD161.9E and VB..61.. 3-port control ball valves

Control ball valves with:						GLD161.9E	
internal threads ¹⁾	Rp	external threads ²⁾	G..B	k _{vs} [m ³ /h]	DN	Δp_{\max}	Δp_s
VBI61.15..	Rp ½"	VBG61.15..	G 1 B	1.6...6.3	15	350	–
VBI61.20..	Rp ¾"	VBG61.20..	G 1 ¼ B	4...6.3	20		
VBI61.25-10	Rp 1"	VBG61.25-10	G 1 ½ B	10	25		
VBI61.32-16	Rp 1¼"	VBG61.32-16	G 2 B	16	32		
VBI61.40-25	Rp 1½"	VBG61.40-25	G 2 ¼ B	25	40		
–	–	VBG61.50-40	G 2 ¾ B	40	50		
VBI61.50..	Rp 2"	–	–	40...63	50		

¹⁾ Data sheet N4211

²⁾ Data sheet N4212

Topic	Title	Document ID
Data sheet	Rotary actuators for ball valves	A6V11171770_en--
Mounting instructions	GLD..9E	A6V11171776_----
Mounting instructions	VAI61.. / VBI61..	M4211
Mounting instructions	VAG61.. / VBG61..	M4212

Related documents such as environmental declarations, CE declarations, etc., can be downloaded at the following Internet address:

<http://siemens.com/bt/download>

Safety

	<p>⚠ Caution</p>
	<p>National safety regulations</p> <p>Failure to comply with national safety regulations may result in personal injury and property damage.</p> <ul style="list-style-type: none"> • Observe national provisions and comply with the appropriate safety regulations. • Use only properly trained technicians for mounting, commissioning, and servicing.



Mounting

Both ball valve and rotary actuator can easily be assembled at the mounting location. Neither special tools nor adjustments are required.

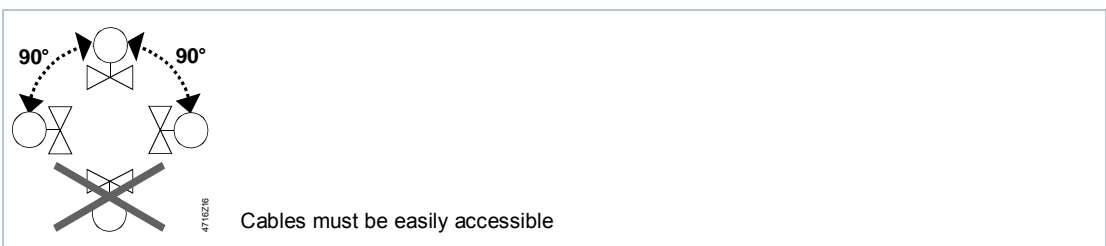
Orientation

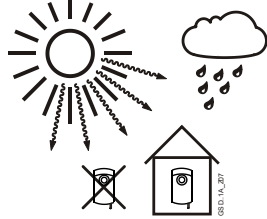
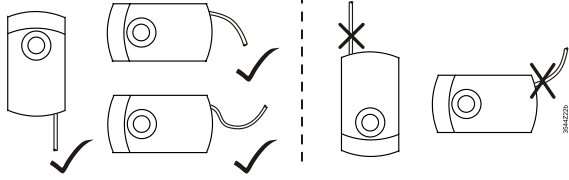

Protection against weather, humidity and dirt

	<p>⚠ IP54</p> 	
Protection against direct sunlight and rain	Correct mounting position and cable connection	Protection only with closed cover!

Installation

	⚠ WARNING
	No internal line protection for supply lines to external consumers Risk of fire and injury due to short-circuits <ul style="list-style-type: none">Adapt the line diameters as per local regulations to the rated value of the installed fuse.

Commissioning

When commissioning the system, check wiring and the functions of the rotary actuator.

Manual adjustment

The rotary actuator can be manually adjusted into any position between 0° and 90° by pushing the gear train disengagement slider.

If a control signal from the controller is present, this will take priority in determining the position after the slider is released.

For manual adjustment: Power off!

Maintenance

The actuators GLD161.9E are maintenance-free.

Disposal

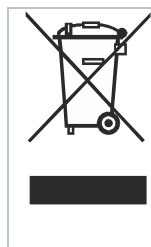

The device is considered electrical and electronic equipment for disposal in terms of the applicable European Directive and may not be disposed of as domestic garbage.

- Dispose of the device through channels provided for this purpose.
- Comply with all local and currently applicable laws and regulations.

Power supply		
Operating voltage (SELV/PELV) / Frequency		AC 24 V ~ ±20 % (19,2...28,8 V ~) / 50/60 Hz DC 24...48 V = ±20 % (19,2...57,6 V =) ¹⁾
Power consumption	running	4.9 VA / 1.8 W
	holding	0.5 W

Function data		
Nominal torque		8 Nm
Maximum torque (blocked)		16 Nm
Nominal rotary angle (with position indication)		90°
Maximum rotary angle (mechanic limitation)		95° ± 2°
Runtime for 90° rotary angle		30 s
Actuator sound power level		32 dB(A)

Inputs	
Positioning signal Input voltage Current consumption Input resistance	(wires 8-2/Y-G0) DC 0/2...10 V \approx 0.1 mA >100 k Ω
Max. permissible input voltage Protected against faulty wiring Hysteresis	DC 35 V \approx limited to DC 10 V \approx max. AC 24 V \sim 60 mV
Outputs	
Position indicator Output signal Output voltage U Max. output current Protected against faulty wiring	(wires 9-2/U-G0) DC 0...10 V \approx DC \pm 1 mA max. AC 24 V \sim / DC 24...48 V \approx
Connection cables	
Cable length	0.9 m
Cross section of prewired connection cables	0.75 mm ²
Permissible length for signal lines	300 m
Degree of protection	
Insulation class	III as per EN 60730
Housing protection	IP54 as per EN 60529
Environmental conditions	
Operation Climatic conditions Mounting location Temperature extended Humidity (non-condensing)	IEC 60721-3-3 Class 3K5 interior, weather-protected -32...+55 °C <95 % r.F.
Transport Climatic conditions Temperature extended Humidity (non-condensing)	IEC 60721-3-2 Class 3K5 / Class 2K3 -32...+70 °C <95 % r.F.
Storage Climatic conditions Temperature extended Humidity (non-condensing)	IEC 60721-3-1 Class 1K3 -32...+50 °C <95 % r.F.
Mechanical conditions	Class 2M2
Standards, directives and approvals	
Product standard	EN 60730 Part 2-14 / Particular requirements for electric actuators
Electromagnetic compatibility (Applications)	For use in residential, commercial, light-industrial and industrial environments
EU Conformity (CE)	A5W00026944 ²⁾
RCM Conformity	A5W00026948 ²⁾
EAC Conformity	Eurasian conformity
UL	UL as per UL 60730 http://ul.com/database cUL ¹⁾ as per CSA-C22.2 No. 24-93

Environmental compatibility

The product environmental declaration A5W00026068²⁾ contains data on environmentally compatible product design and assessments (RoHS compliance, materials composition, packaging, environmental benefit, disposal).

Dimensions

Actuator W x H x D

see „Dimensions“, p. 8

Weight

Without packaging

0.69 kg

¹⁾ Permitted only to DC 30 V \equiv

²⁾ The documents can be downloaded from <http://siemens.com/bt/download>.

Internal Diagram

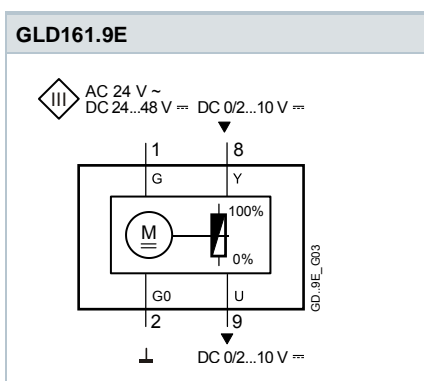

Connection diagram

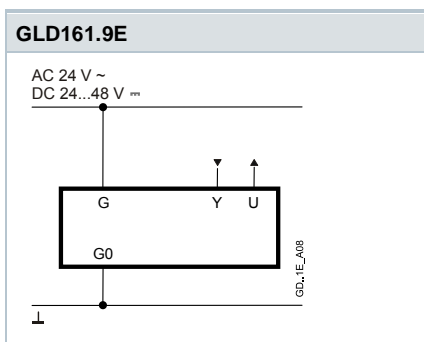

Cable labeling

Pin	Code	No	Color	Abbreviation	Meaning
Actuators	G	1	red	RD	System potential AC 24 V ~ / DC 24...48 V \equiv
AC 24 V ~	G0	2	black	BK	System neutral
DC 24...48 V \equiv	Y	8	grey	GY	Signal-in
	U	9	pink	PK	Signal-out

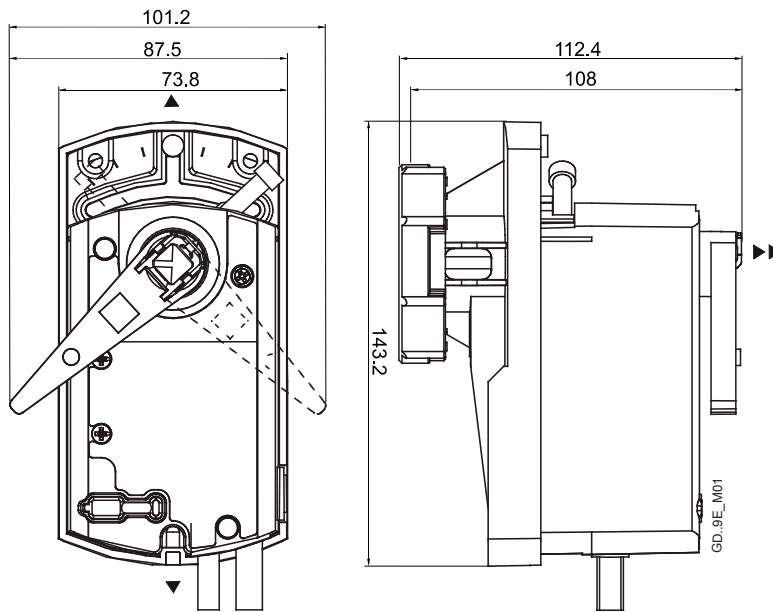

Dimensions in mm

- ▶ = > 100 mm
- ▶▶ = > 200 mm

Minimum clearance from ceiling or wall for mounting, connection, operation, maintenance etc.