

Cerberus™ FIT

## Fire control panels FC360

FC361-ZZ, FC361-ZA, FC361-YZ, FC361-YA



### Fire control panels (1-loop) for addressable peripheral devices with integrated operating unit

- One loop with 126 addresses or two stubs each with 32 addresses
- Two collective horn lines
- Three freely programmable relay outputs
- Four freely programmable control inputs/outputs
- Optional RS232 module
- Optional module with four freely configurable monitored outputs
- Integrated web-server-based 'FC360 Panel Configurator' software, access via Ethernet connection (port)
- Installation space for optional components:
  - LED indicator (16 zones)
  - Key switch (standard) or key switch (Nordic)
  - Evacuation module (NL)
- Emergency power supply for emergency operating time of up to 72 hours

The FC361-xx is a compact fire control panel with an integrated operating unit. An 'C-NET' detector line with up to 126 addressable devices can be connected on a single loop. It is also possible to connect up to two stub lines instead of a loop.

Automatic fire detectors, manual call points, input/output modules, and other 'C-NET' devices can be connected to the detector line.

You will find more information in the 'List of compatibility', document A6V10882301.

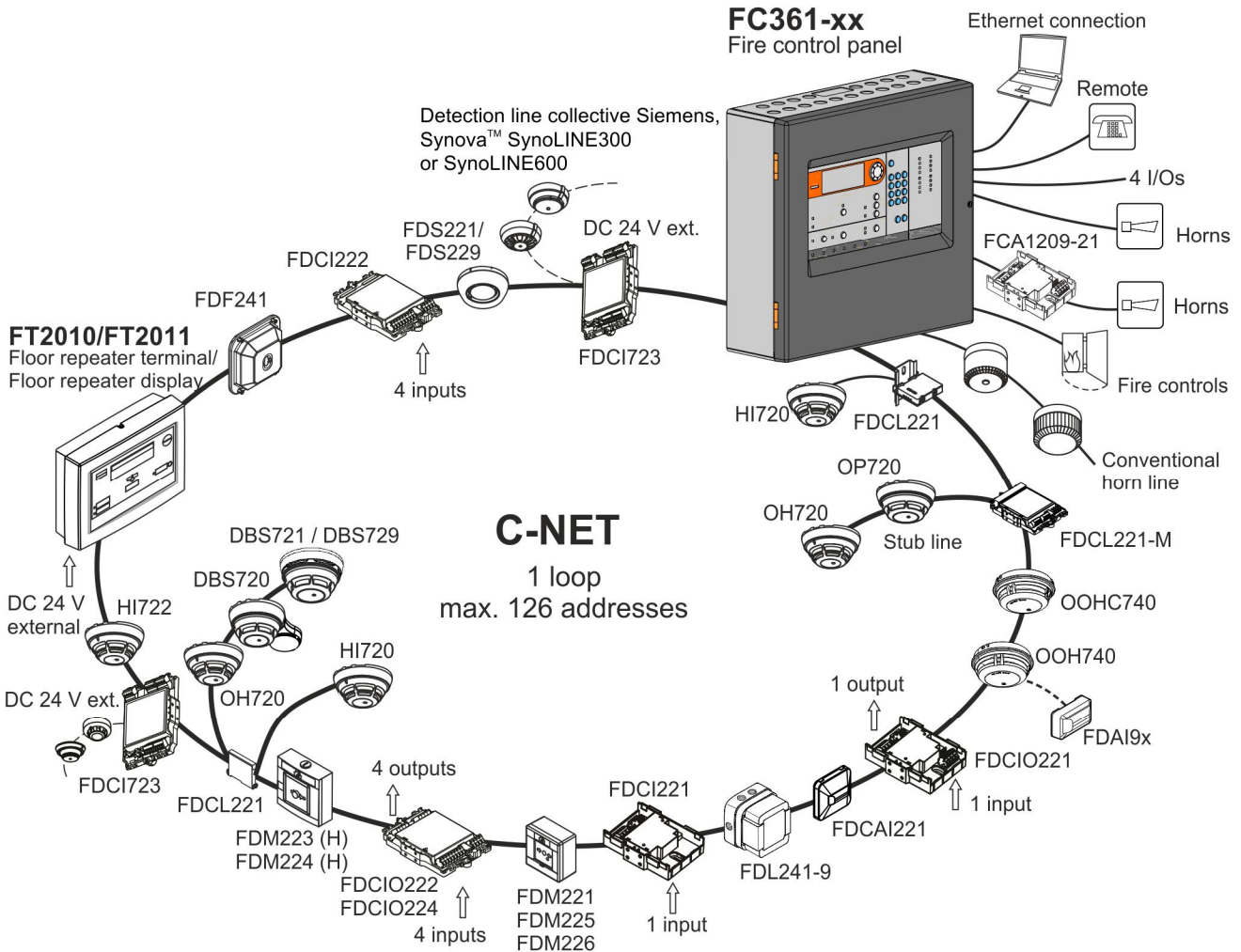

- The 'FC360 Panel Configurator' software is used to configure the fire control panel. All customer texts as well as individual zones and output controllers can be adapted with the 'FC360 Panel Configurator' software.
- Monitoring of the detector line for short-circuit and open line:
  - Precision localization of the error location is possible.
  - None of the devices on the detector line are lost in the event of a short-circuit on the loop.
- Up to 2000 events can be called up according to various criteria.
- Changeover to summer time and winter time is automatic.
- Individual customer text per zone containing up to 42 characters
- The 'Manned'/'Unmanned' operation modes can be selected.

The FC361-xx is ideal for smaller fire detection installations such as those in the following buildings, for example:

- Workshops
- Hotels
- Schools
- Shops
- Residential homes

### Display and operating unit

The following components are located on the operating unit:

- The electronic components for the operating unit
- Optional:
  - Key switch (standard or Nordic)
  - LED indicator (16 zones)
  - Evacuation module (NL)

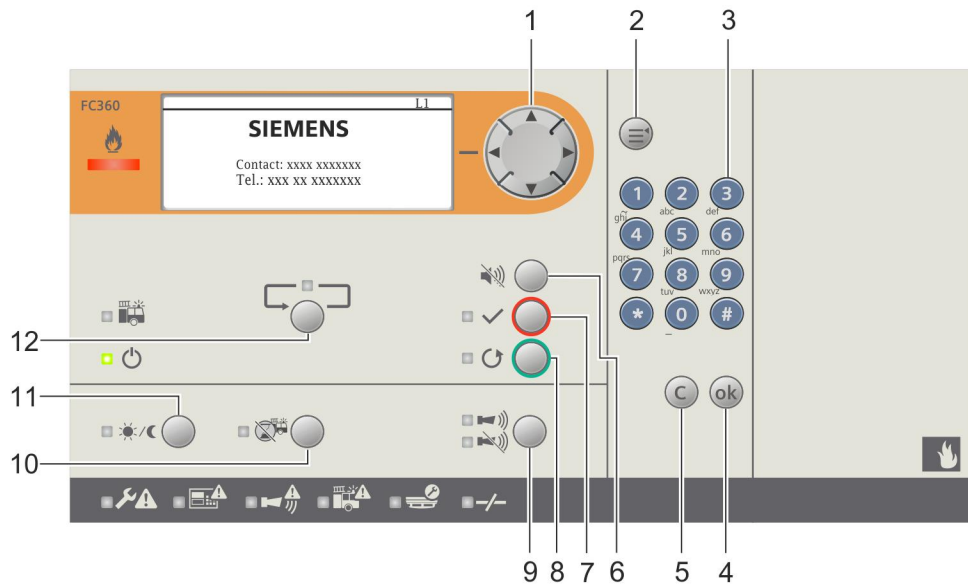

No	Designation
1	Navigation button
2	Menu button
3	Keypad for entering numeric and alphanumeric texts, e.g., password, customer text, etc.
4	OK button (to confirm your selection)
5	C button ('Cancel')
6	Button for 'Buzzer OFF'
7	Button for 'Acknowledge' message
8	Button for 'Reset' message
9	'Mute'/'Unmute' button for sounder control
10	Button for 'Alarm delay OFF'
11	Button for 'Manned'/'Unmanned' operation modes
12	Button for scrolling through alarm messages

## **Mainboard**

The following components are located on the mainboard:

- A slot for the RS232 module
- CPU module
- An Ethernet port
- The connection terminals for the C-NET detector line (one loop or up to two stubs)
- Two monitored collective horn lines
- Three freely configurable relays (remote transmission – fire – fault, fire control)
- Four freely programmable control inputs/outputs
- One DC 24 V voltage output

### **Optional:**

- Output module (4M) equipped with 4 monitored freely configurable outputs for alarm devices, fire control, and transmission paths for alarm and fault

### **Power supply 70 W**

- The power supply feeds the hardware and charges the batteries.

### **Emergency power supply**

- In the event of a power cut, the batteries provide emergency current for up to 72 hours.

### **Configuration**

- Customer-specific adaptations to the system can be made with the integrated 'FC360 Panel Configurator'.

## Configuration

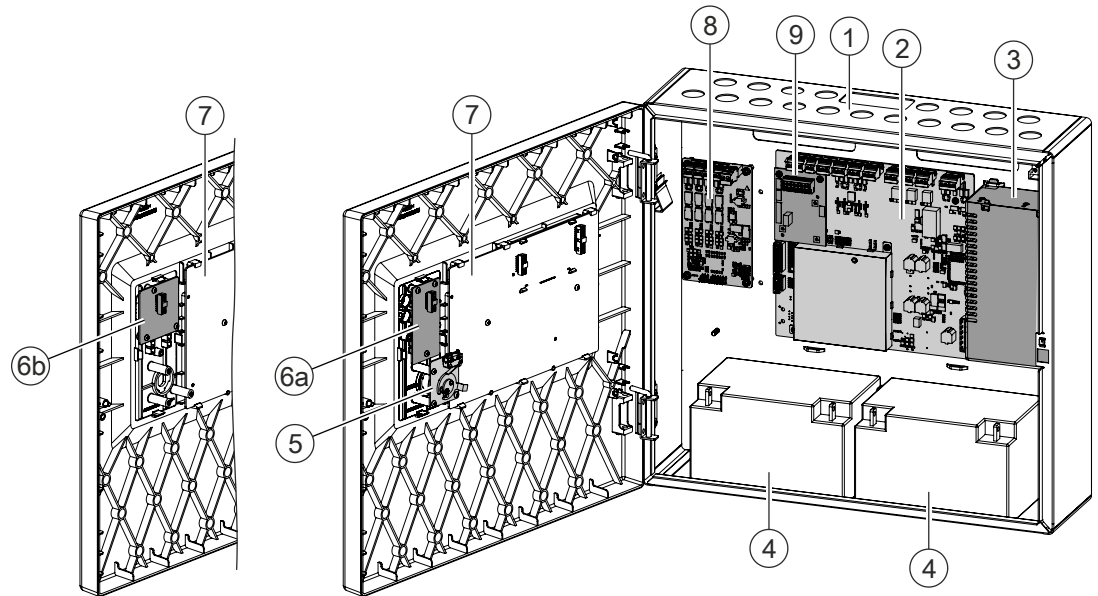



Item	Designation	Type	Notes
1	Housing	–	Items 1...3 and item 7 -> basic equipment for each FC361-xx
2	Mainboard	–	
3	Power supply (70 W)	FP2015-A1	
4	Batteries	FA200x-A1	2x 12 V
5	Key switch	FCA3601-Z1	Optional <sup>1</sup> , for access authorization for operation
	Key switch (Nordic)	FCA3603-Z1	
6a	LED indicator (16 zones)	FTO3602-Z1	Optional <sup>2</sup>
6b	Evacuation module (NL)	FTO3601-H1	Optional <sup>2</sup>
7	PMI	–	Basic equipment
8	Output module (4M)	FCA3602-Z1	Optional
9	RS232 module (isolated)	FCA2001-A1	Optional



<sup>1</sup> Not in conjunction with the evacuation module (NL)

<sup>2</sup> Either LED indicator (16 zones) or evacuation module (NL): The LED indicator (16 zones) and the evacuation module (NL) cannot be installed at the same time.

Fire control panels FC361-xx

Type	Order number	Designation
FC361-ZZ	S54433-C112-A1	Fire control panel (1L, Comp.)
FC361-ZA	S54433-C111-A1	Fire control panel (1L, Comf.)
FC361-YZ	S54433-C110-A1	Fire control panel (1L, Comp., LED)
FC361-YA	S54433-C109-A1	Fire control panel (1L, Comf., LED)

FC361-ZZ	FC361-ZA
Battery: Max. 2x 12 V, 12 Ah Without integrated LED indicator for 16 zones	Battery: Max. 2x 12 V, 25 Ah Without integrated LED indicator for 16 zones
	

FC361-YZ	FC361-YA
Battery: Max. 2x 12 V, 12 Ah With integrated LED indicator for 16 zones	Battery: Max. 2x 12 V, 25 Ah With integrated LED indicator for 16 zones
	

Accessories

Extensions

Type	Order number	Designation
FTO3602-Z1	S54433-B117-A1	LED indicator (16 zones)
FCA3601-Z1	S54433-N113-A1	Key switch
FCA3603-Z1	S54433-N115-A1	Key switch (Nordic)

Type	Order number	Designation
FTO3601-H1	S54433-B116-A1	Evacuation module (NL)
FCA2001-A1	A5Q00005327	RS232 module (isolated)
FCA3602-Z1	S54433-A114-A1	Output module (4M)
FCA1209-Z1	S54400-B124-A1	Output module (230 V)

#### Auxiliary power supply

Type	Order number	Designation
FP120-Z1	S54400-S122-A1	Power supply kit A 70 W

#### Batteries

Type	Order number	Designation
FA2003-A1	A5Q00019353	Battery (12 V, 7 Ah, VdS)
FA2004-A1	A5Q00019354	Battery (12 V, 12 Ah, VdS)
BAT12-25	S54302-Z102-A1	Battery (12 V, 25 Ah, VdS)

#### External printer

Type	Order number	Designation
DL3750+	A5Q00023962	Matrix printer (external)
–	A5Q00023963	Color ribbon for matrix printer DL3750+

#### Spare part

Type	Order number	Designation
FP2015-A1	S54400-B121-A1	Power supply (70 W)
FCM3601-Z1	S54443-A115-A1	Mainboard
FHD3601-Z1	S54443-B118-A1	Door incl. PMI

#### Mounting accessories

Type	Order number	Designation
FHA3602-Z1	S54433-N118-A1	Semi-flush mount bezel

#### Tools

Type	Order number/Document ID	Comment
FC360 Panel Configurator	—	Scope of supply for FC361-xx control panels
FX3610 Cerberus FIT Quantities tool	A6V10885143	—

Document ID	Name
A6V10421795	Technical Manual of Fire Control Panels FC361-xx
A6V10450595	Operation Manual of FC360 Desktop Editor and FC360 Panel Configurator
A6V10882301	List of compatibility (for 'FC360' product line)
A6V10421792	Installation of Fire Control Panels FC361-xx
A6V10893024	Installation Semi flush mount bezel FHA3602-Z1

Technical data

General data	
Number of detector lines	
<ul style="list-style-type: none"> <li>• Loop or</li> <li>• Stub lines</li> </ul>	Max. 1 Max. 2
Number of addresses	Max. 126
Operating unit	Integrated
Dimensions (W x H x D)	
<ul style="list-style-type: none"> <li>• FC361-ZZ / FC361-YZ</li> <li>• FC361-ZA / FC361-YA</li> </ul>	402 x 372 x 132 mm 402 x 372 x 211 mm
Color:	
<ul style="list-style-type: none"> <li>• Housing / cover cap</li> </ul>	~RAL 7035, light gray

Inputs / outputs	
Integrated inputs/outputs	
<ul style="list-style-type: none"> <li>• Outputs for horn</li> <li>• Relay outputs for fire control and transmission paths for alarm and fault</li> </ul>	2 3
Freely configurable inputs/outputs	4
Options:	
Output module (4M) with 4 monitored outputs for alarm devices, fire control, and transmission paths for alarm and fault	1

Connections	
Slot for serial interface RS232	Max. 1
Ethernet port RJ45	Max. 1
LED indication	Max. 1
Key switch (standard)	Max. 1
Key switch (Nordic)	Max. 1
Evacuation module (NL)	Max. 1



Connections	
Output card (4M)	Max. 1
Connectable detector series	Cerberus™ PRO FD720 (C-NET) according to 'List of compatibility'. See 'Product documentation' section
External printer DL3750+	Connection via RS232 interface

Performance data	
Mains voltage	AC 97...127 V AC 196...253 V
Power supply	70 W
Operating voltage	DC 20.5...28.6 V
Operating current	Max. 2.5 A
Battery capacity	Max. 2x 12 V, 12 Ah (FC361-ZZ, FC361-YZ) Max. 2x 12 V, 25 Ah (FC361-ZA, FC361-YA)
Battery bridging time	Up to 72 h
Battery monitoring	Yes
Mains supervision	Yes

Ambient conditions and protection category	
Operating temperature	-5...+40 °C
Storage temperature	-20...+60 °C
Air humidity (no condensation permitted)	≤95 % rel.
Protection category (IEC 60529)	IP30

Standards and approvals	
Standards	EN 54-2, EN 54-4, EN 54-13
Approvals: • LPCB	531q/03

16  0786	<b>FC361-YA / FC361-YZ / FC361-ZA / FC361-ZZ</b>	Siemens Switzerland Ltd, Gubelstrasse 22 CH-6301 Zug, Switzerland Technical data: see doc. <b>A6V10421795</b>
FC361 - Control and Indicating Equipment incl. FP2015 - 70W/24VDC Power Supply Equipment in fire detection and fire alarm systems installed in buildings		
305/2011/EU (CPR): EN 54-2 / EN 54-4 ; 2014/30/EU (EMC): EN 50130-4 / EN 61000-6-3 ; 2014/35/EU (LVD): EN 60950-1 ; 2011/65/EU (RoHS): EN 50581		
Declared performance and conformity can be seen in the Declaration of Performance and the EC Declaration of Conformity, which is obtainable via the Customer Support center: Tel. +49 89 9221-8000 or <a href="http://siemens.com/bt/download">http://siemens.com/bt/download</a>		
DoP No.: 0832-CPR-F1346; DoC No.: CED-FC361		

Issued by  
Siemens Switzerland Ltd  
Building Technologies Division  
International Headquarters  
Gubelstrasse 22  
CH-6301 Zug  
Tel. +41 41-724 24 24  
[www.siemens.com/buildingtechnologies](http://www.siemens.com/buildingtechnologies)

© Siemens Switzerland Ltd, 2014  
Technical specifications and availability subject to change without notice.